

SS 6 HIRSCHMANN

Spherical plain bearings

TYPE: Plain bearings, Spherical plain bearings and rod ends, Radial spherical plain bearings, Requiring maintenance, Series PB

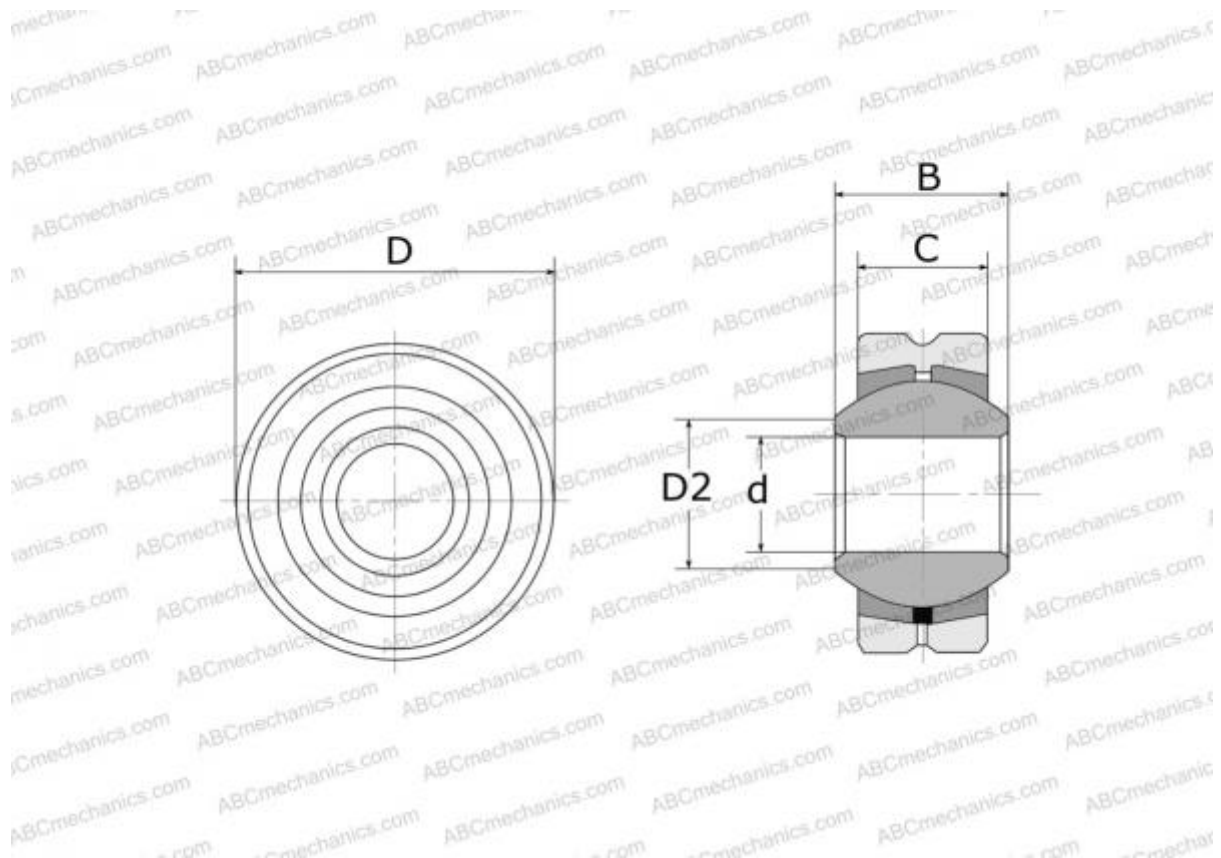

Technical specification

DIMENSIONS, MM

d	6,000
D	18,000
D2	9,000
B	9,000
C	6,750

WEIGHT, KG 0,013

MANUFACTURER [HIRSCHMANN](#)

INTERCHANGE

ABC	PB 6
IKO	PB 6