

PB 8 IKO

Spherical plain bearings

TYPE: Plain bearings, Spherical plain bearings and rod ends, Radial spherical plain bearings, Requiring maintenance, Series PB

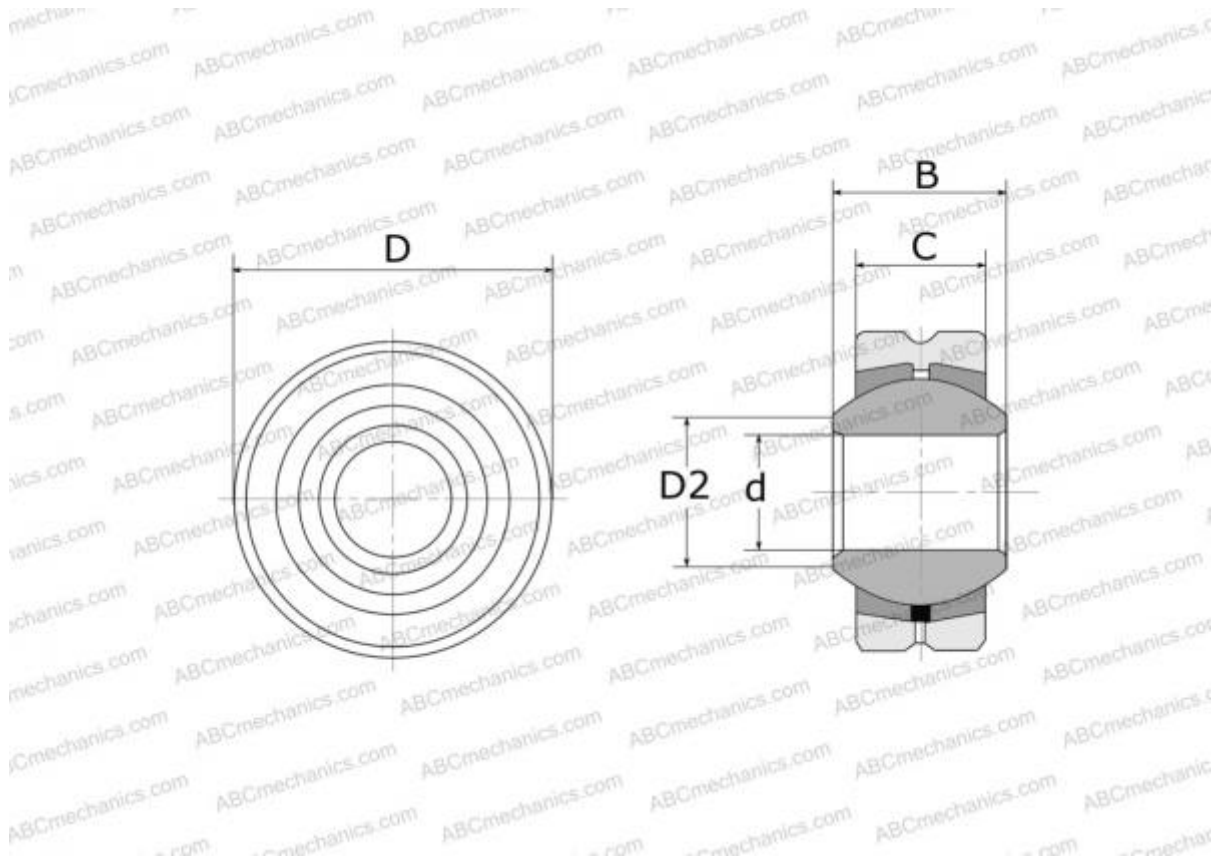

Technical specification

DIMENSIONS, MM

d	8,000
D	22,000
D2	10,400
B	12,000
C	9,000

WEIGHT, KG 0,024

MANUFACTURER [IKO](#)

INTERCHANGE

ABC	PB 8
HIRSCHMANN	SS 8

CALCULATION DATA

Basic dynamic load rating, C	7,010 kN
Basic static load rating, Co	16,800 kN