

PB 10 IKO

Spherical plain bearings

TYPE: Plain bearings, Spherical plain bearings and rod ends, Radial spherical plain bearings, Requiring maintenance, Series PB

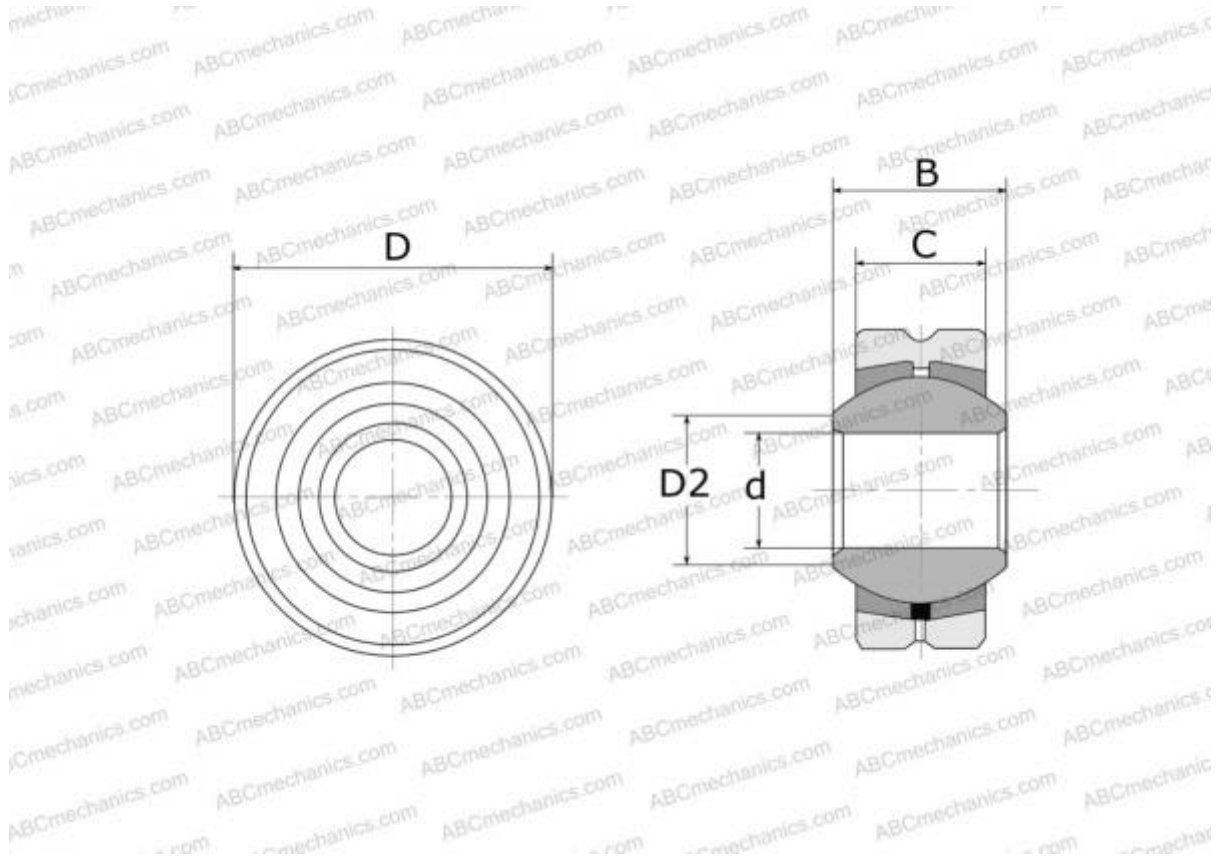

Technical specification

DIMENSIONS, MM

d	10,000
D	26,000
D2	12,900
B	14,000
C	10,500

WEIGHT, KG 0,039

MANUFACTURER [IKO](#)

INTERCHANGE

ABC	PB 10
HIRSCHMANN	SS 10

CALCULATION DATA

Basic dynamic load rating, C	9,810 kN
Basic static load rating, Co	23,500 kN