

PB 18 ABC

Spherical plain bearings

TYPE: Plain bearings, Spherical plain bearings and rod ends, Radial spherical plain bearings, Requiring maintenance, Series PB

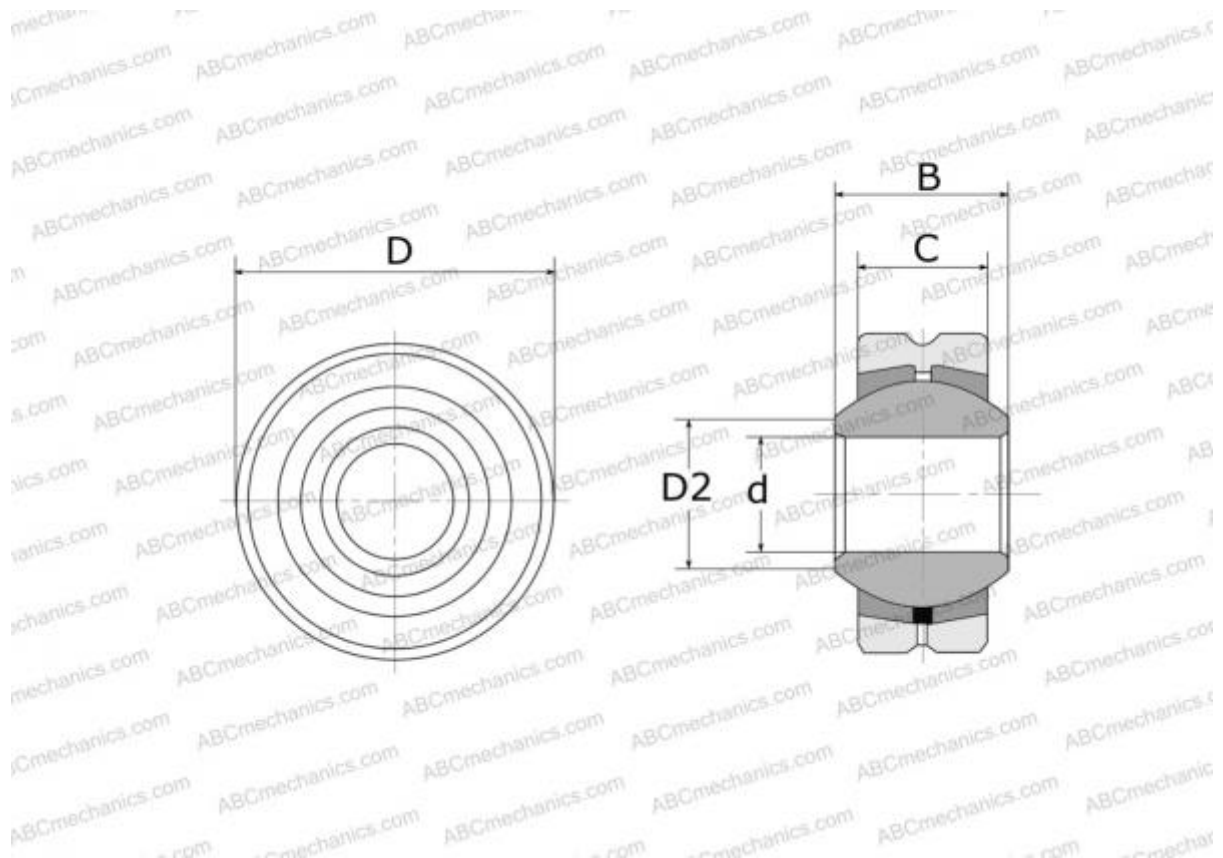

Technical specification

DIMENSIONS, MM

d	18,000
D	42,000
D2	21,900
B	23,000
C	16,500

WEIGHT, KG 0,160

MANUFACTURER [ABC](#)

INTERCHANGE

IKO	PB 18
HIRSCHMANN	SS 18