

SS 18 HIRSCHMANN

Spherical plain bearings

TYPE: Plain bearings, Spherical plain bearings and rod ends, Radial spherical plain bearings, Requiring maintenance, Series PB

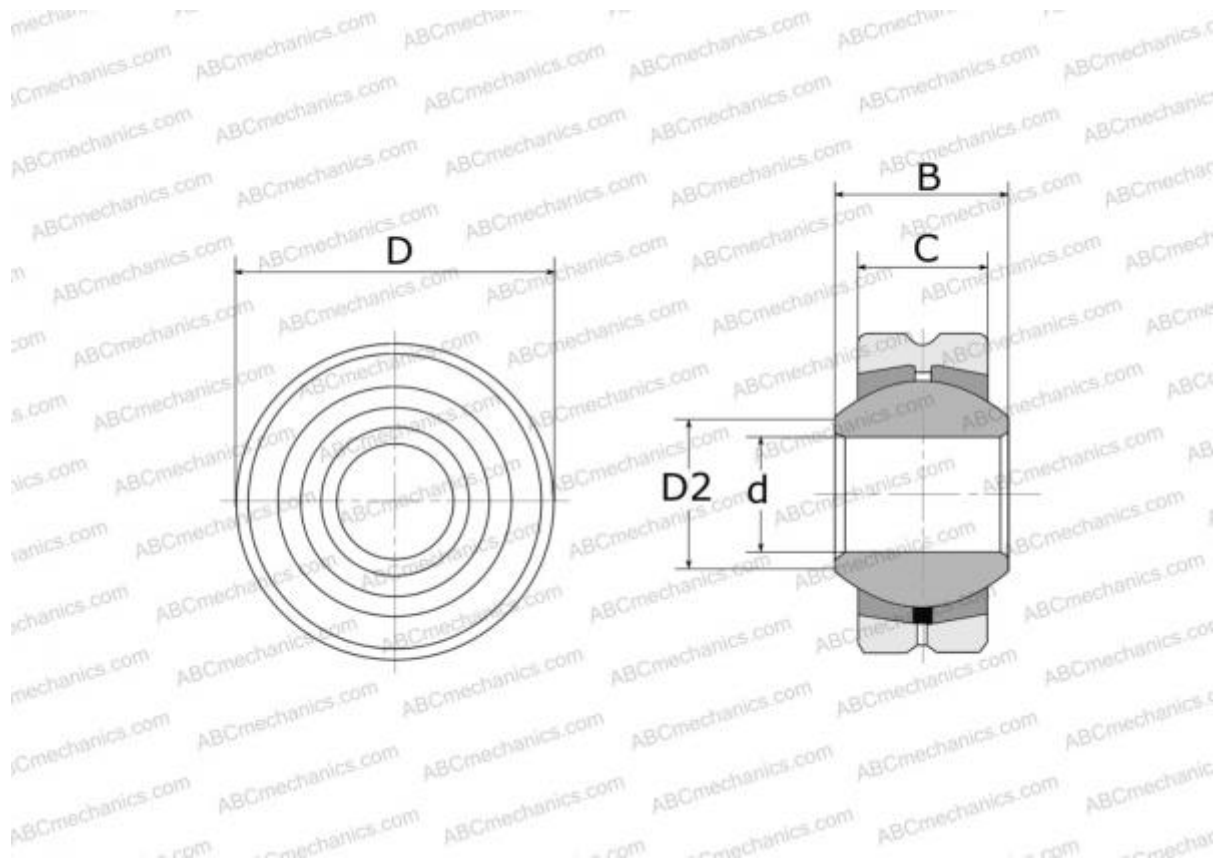

Technical specification

DIMENSIONS, MM

d	18,000
D	42,000
D2	21,900
B	23,000
C	16,500

WEIGHT, KG 0,160

MANUFACTURER [HIRSCHMANN](#)

INTERCHANGE

ABC	PB 18
IKO	PB 18