

SS 20 HIRSCHMANN

Spherical plain bearings

TYPE: Plain bearings, Spherical plain bearings and rod ends, Radial spherical plain bearings, Requiring maintenance, Series PB

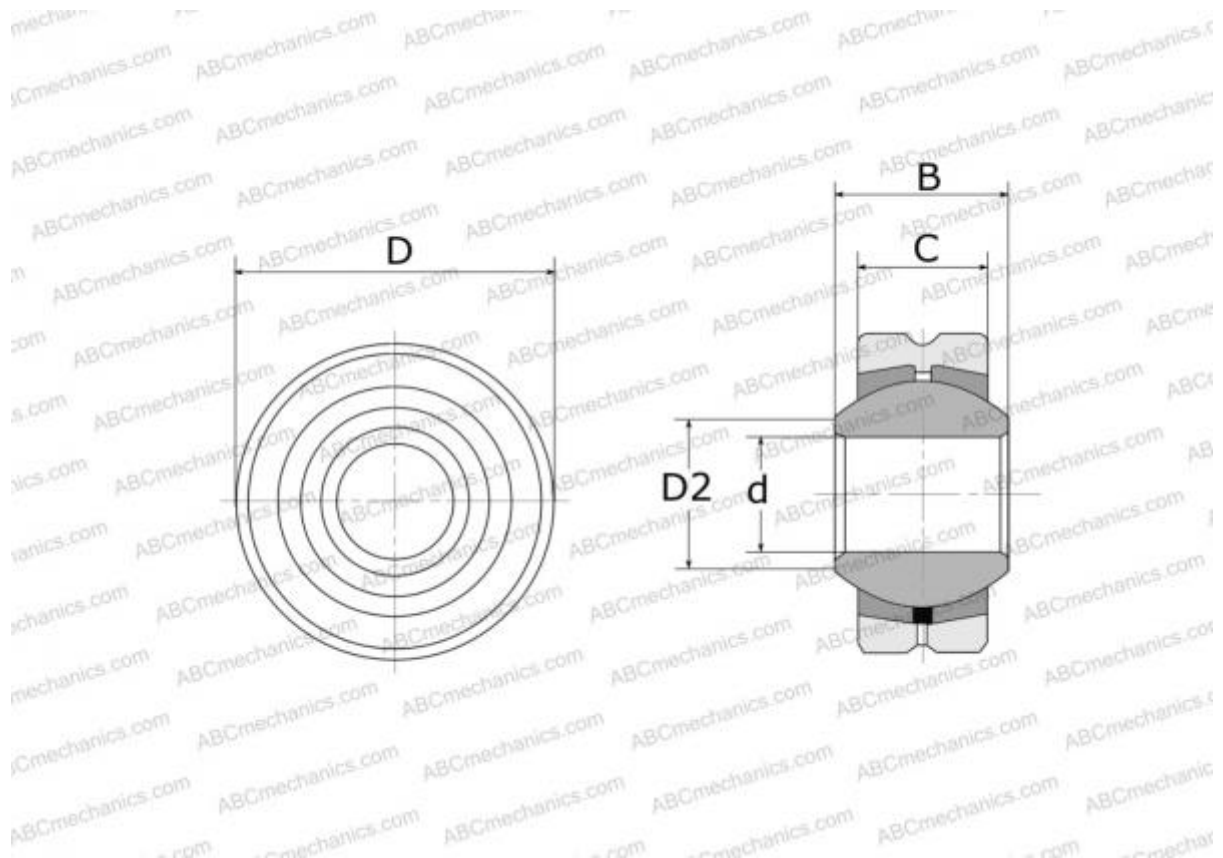

Technical specification

DIMENSIONS, MM

d	20,000
D	46,000
D2	24,400
B	25,000
C	18,000

WEIGHT, KG 0,210

MANUFACTURER [HIRSCHMANN](#)

INTERCHANGE

ABC	PB 20
IKO	PB 20