

PB 22 IKO

Spherical plain bearings

TYPE: Plain bearings, Spherical plain bearings and rod ends, Radial spherical plain bearings, Requiring maintenance, Series PB

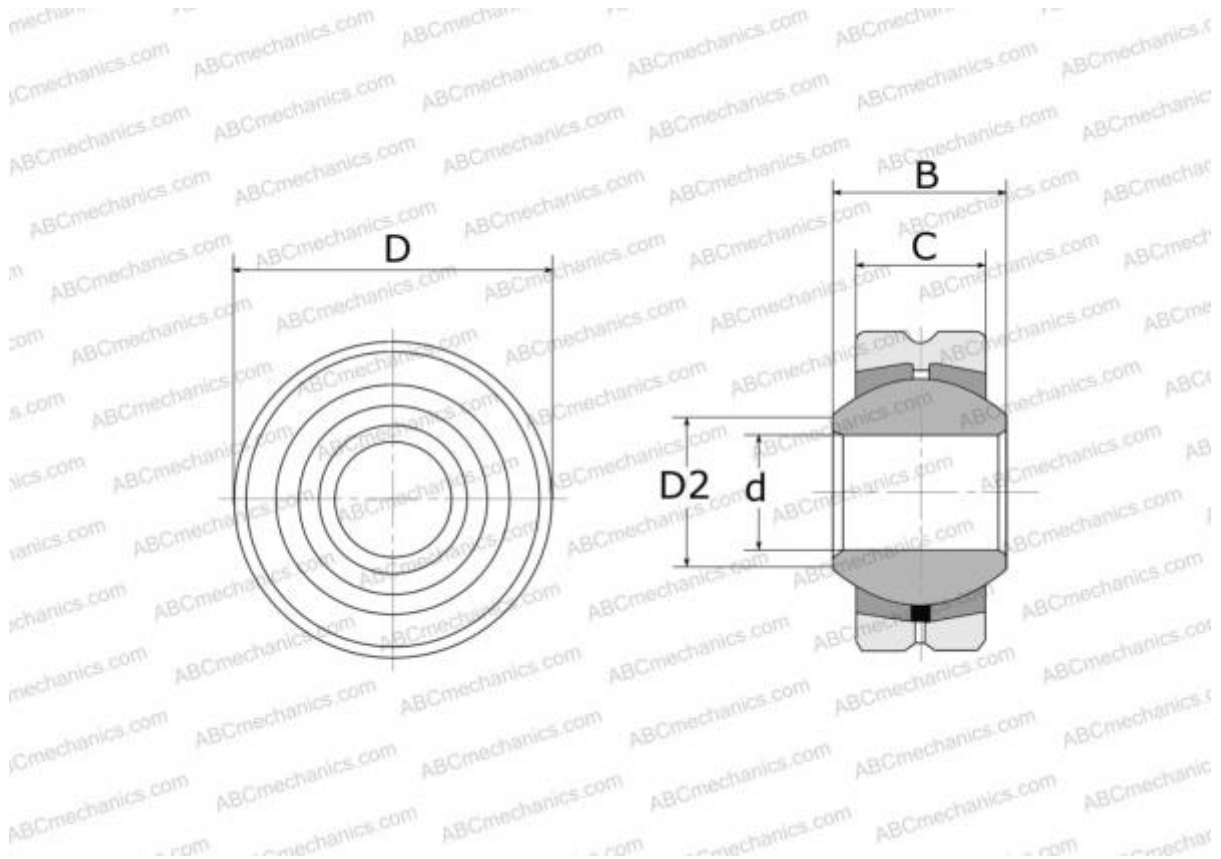

Technical specification

DIMENSIONS, MM

d	22,000
D	50,000
D2	25,800
B	28,000
C	20,000

WEIGHT, KG 0,265

MANUFACTURER [IKO](#)

INTERCHANGE

ABC	PB 22
HIRSCHMANN	SS 22

CALCULATION DATA

Basic dynamic load rating, C	37,400 kN
Basic static load rating, Co	89,700 kN