

## SFL4 HEIM

Rod ends

TYPE: Plain bearings, Spherical plain bearings and rod ends, Rod ends, Requiring maintenance, With internal thread, open design, left hand thread, series GIKL..PB, SILKAC, PHS..L

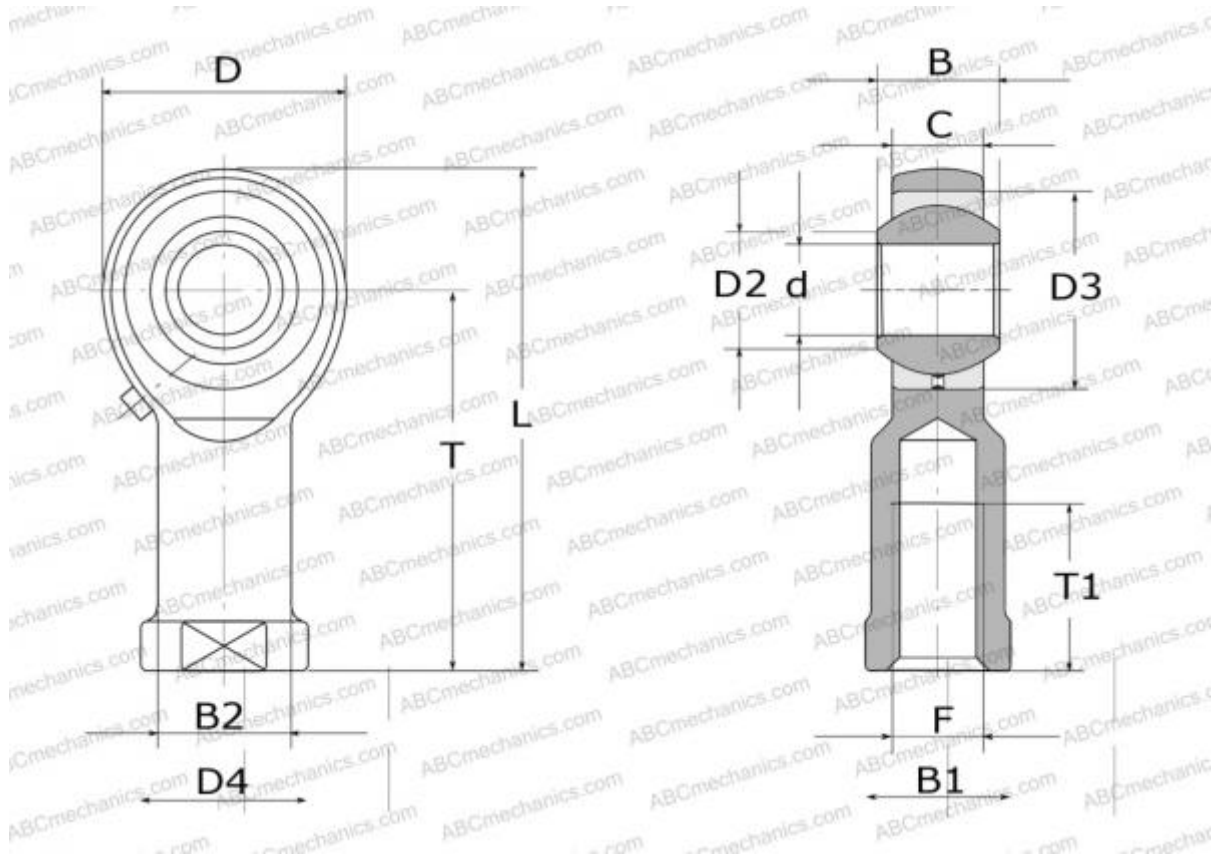

### Technical specification

#### DIMENSIONS, MM

d	4,000
D	14,000
D2	6,500
B	7,000
B1	8,000
L	31,000
T	24,000
T1	12,000
C	5,300
F	M4x0.7

**MANUFACTURER** [HEIM](#)

#### INTERCHANGE

ABC	<a href="#">PHS 4 L</a>
IKO	<a href="#">PHS 4 L</a>

#### INTERCHANGE

AURORA [MG-M4](#)