

## POS 18 ABC

Rod ends

TYPE: Plain bearings, Spherical plain bearings and rod ends, Rod ends, Requiring maintenance, With internal thread, open design, right hand thread, series GAKR..PB, SAKAC, POS

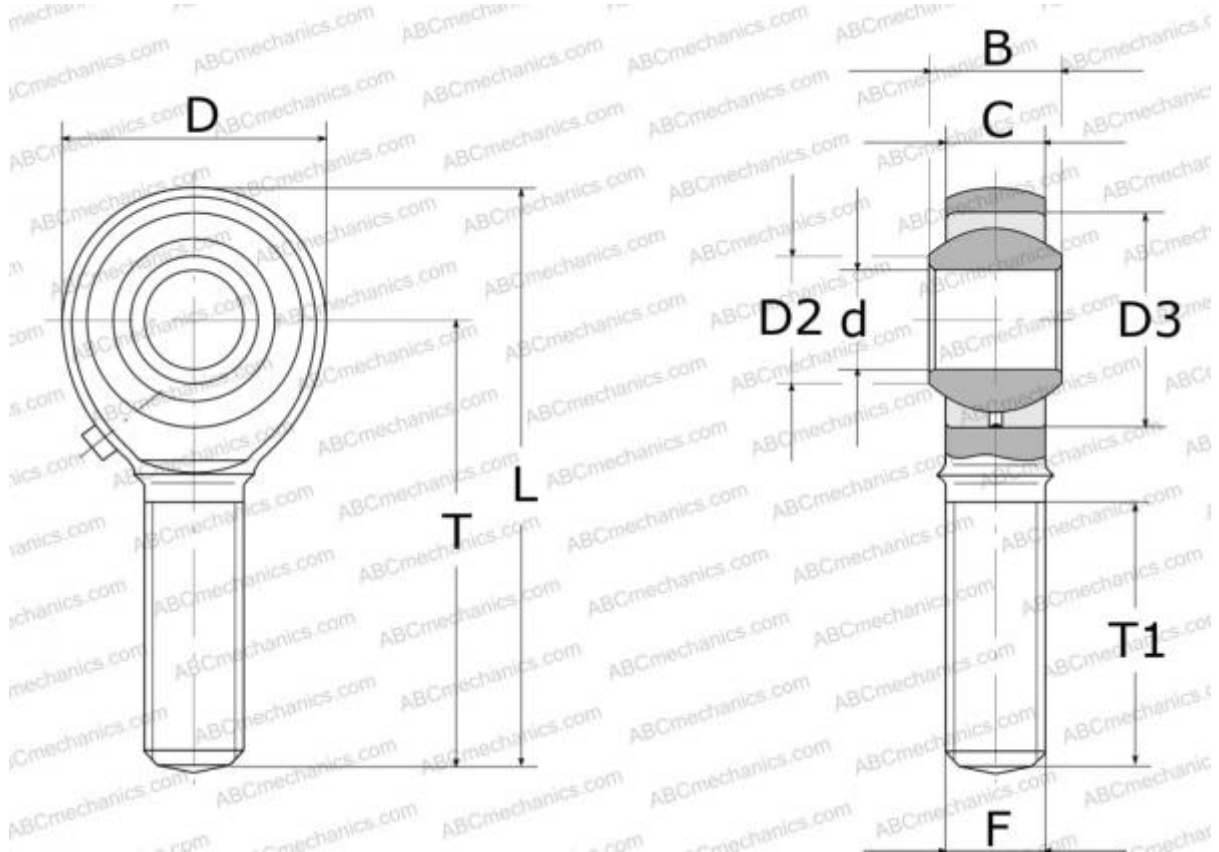

### Technical specification

#### DIMENSIONS, MM

d	18,000
D	42,000
D2	21,900
B	23,000
L	93,000
T	72,000
T1	44,000
C	16,500
F	M18x1.5

**WEIGHT, KG** 0,260

**MANUFACTURER** [ABC](#)

#### INTERCHANGE

IKO [POS 18](#)

#### INTERCHANGE

SKF	<a href="#">SAKAC 18 M</a>
HIRSCHMANN	<a href="#">SM 18</a>
HEIM	<a href="#">SMG 18</a>
AURORA	<a href="#">MM-M18Z</a>