

POS 4 L IKO

Rod ends

TYPE: Plain bearings, Spherical plain bearings and rod ends, Rod ends, Requiring maintenance, With internal thread, open design, left hand thread, series GAKL..PB, SALKAC, POS..L

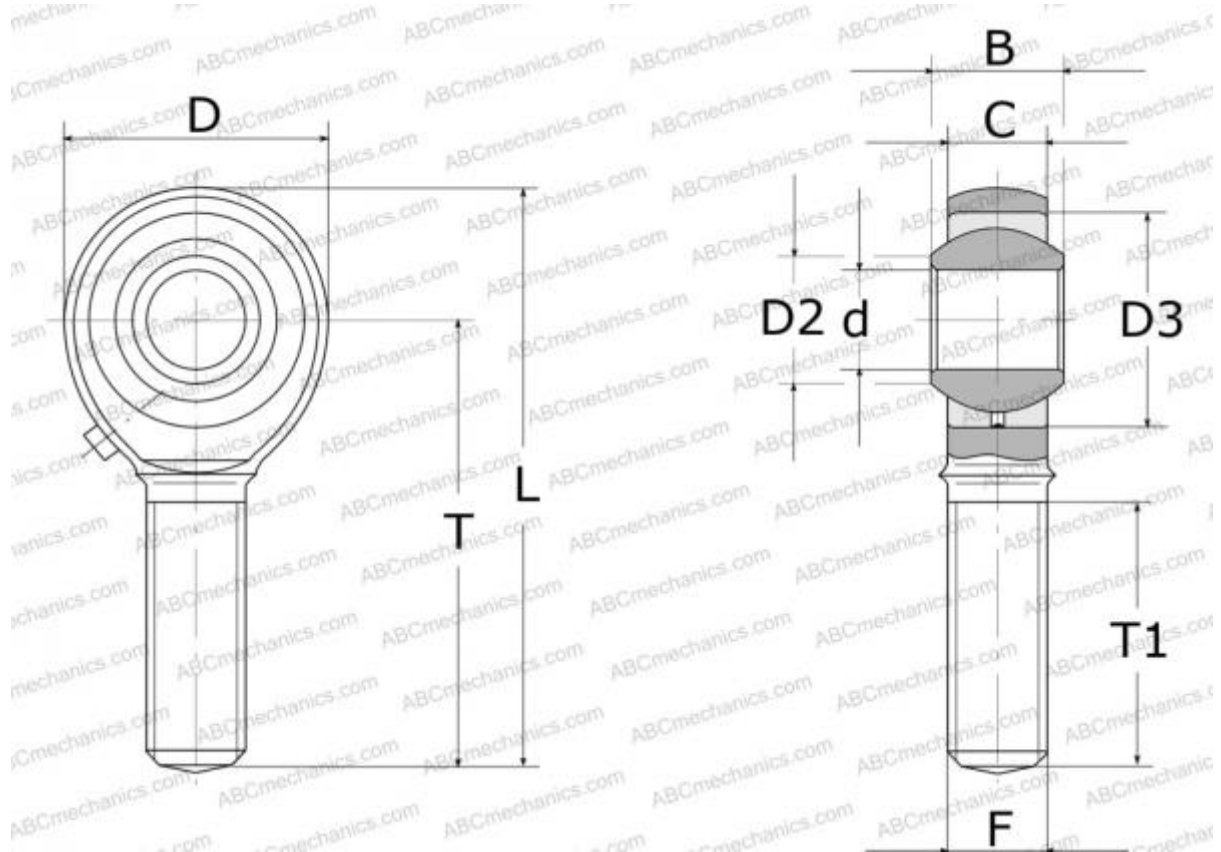

Technical specification

DIMENSIONS, MM

d	4,000
D	14,000
D2	6,500
B	7,000
L	37,000
T	30,000
T1	17,000
C	5,300
F	M4x0.7

WEIGHT, KG 0,008

MANUFACTURER [IKO](#)

INTERCHANGE

ABC [POS 4 L](#)