

POS 5 IKO

Rod ends

TYPE: Plain bearings, Spherical plain bearings and rod ends, Rod ends, Requiring maintenance, With internal thread, open design, left hand thread, series GAKL..PB, SALKAC, POS..L

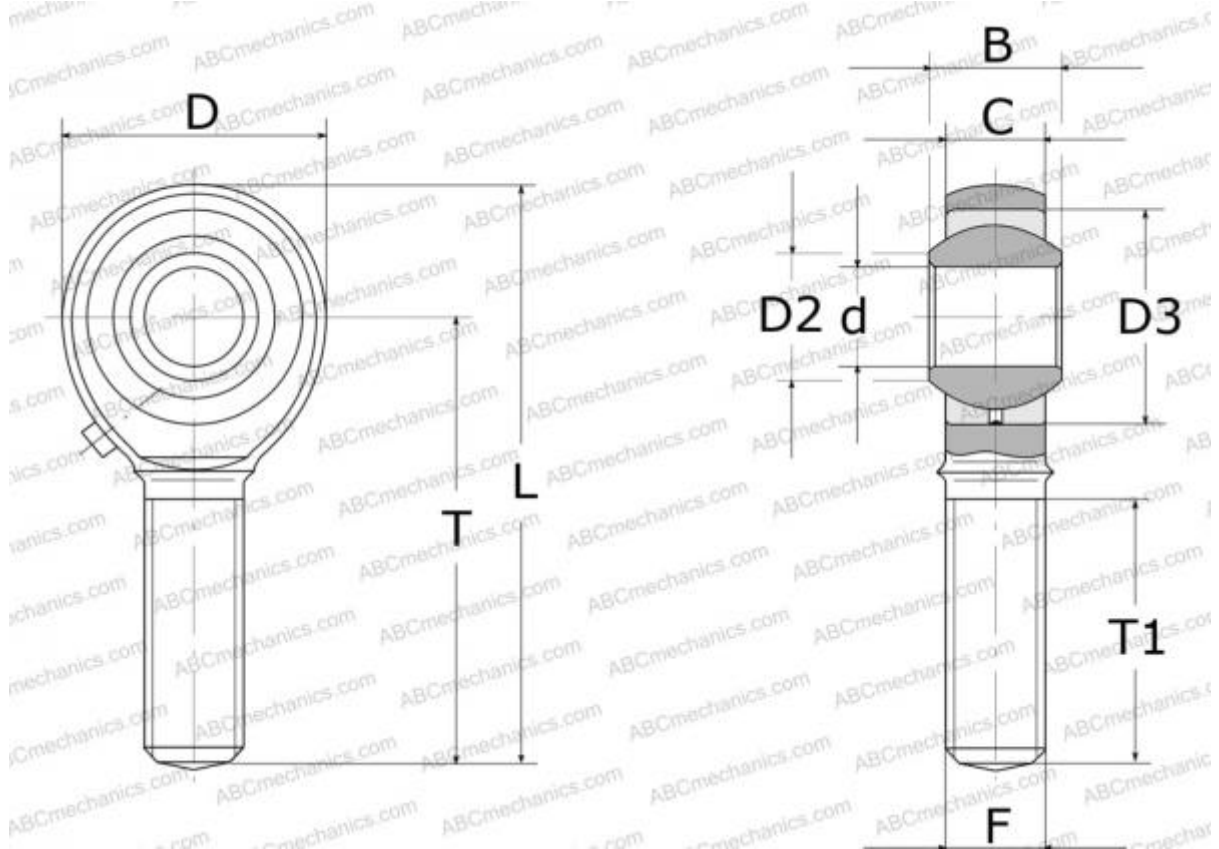

Technical specification

DIMENSIONS, MM

d	5,000
D	16,000
D2	7,700
B	8,000
L	41,000
T	33,000
T1	20,000
C	6,000
F	M5x0.8

WEIGHT, KG 0,013

MANUFACTURER [IKO](#)

CALCULATION DATA

Basic dynamic load rating, C 3,270 kN

CALCULATION DATA

Basic static load rating, Co 3,340 kN