

PHSB 3 L IKO

Rod ends

TYPE: Plain bearings, Spherical plain bearings and rod ends, Rod ends, Requiring maintenance, With internal thread, open design, right hand thread, inch, series PHSB..L

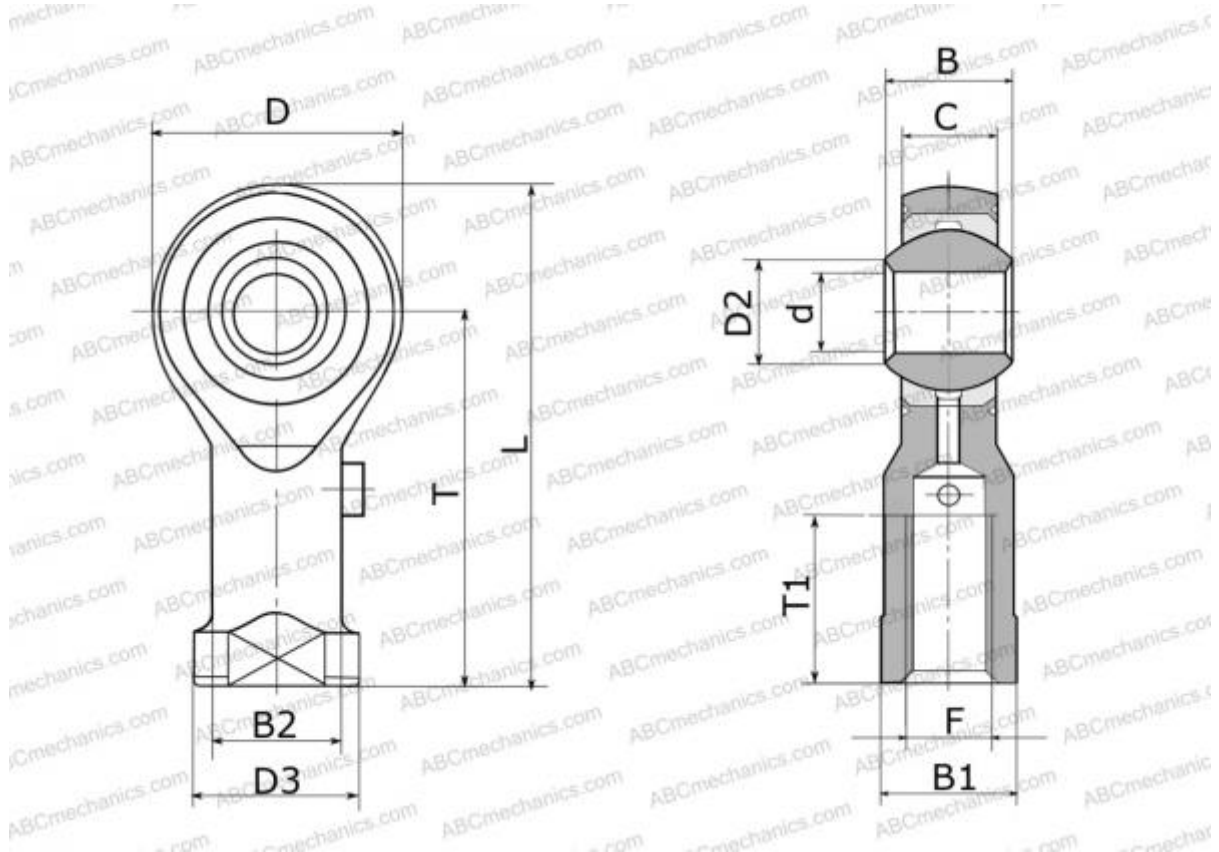

Technical specification

DIMENSIONS, MM

d	4,826
D	15,880
D2	7,770
B	7,920
B1	7,920
L	34,930
T	26,970
T1	14,270
C	6,350
F	.1900-32UNF

WEIGHT, KG 0,015

MANUFACTURER [IKO](#)

INTERCHANGE

ABC [PHSB 3 L](#)

CALCULATION DATA

Basic dynamic load rating, C	3,460 kN
Basic static load rating, Co	9,090 kN