

PHSB 4 L ABC

Rod ends

TYPE: Plain bearings, Spherical plain bearings and rod ends, Rod ends, Requiring maintenance, With internal thread, open design, right hand thread, inch, series PHSB..L

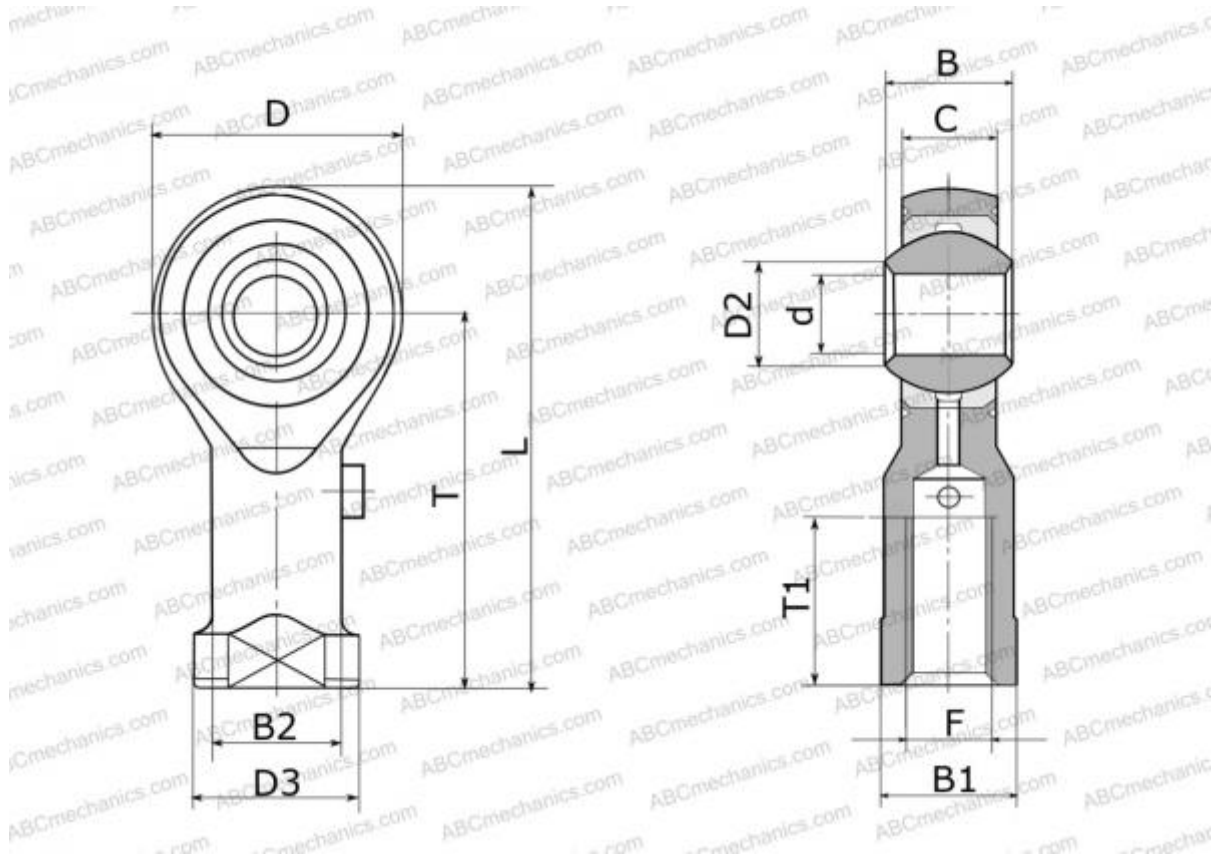

Technical specification

DIMENSIONS, MM

d	6,350
D	19,050
D2	9,020
B	9,530
B1	9,530
L	42,850
T	33,320
T1	19,050
C	7,140
F	.2500-28UNF

WEIGHT, KG 0,025

MANUFACTURER [ABC](#)

INTERCHANGE

IKO

[PHSB 4 L](#)