

POSB 3 L ABC

Rod ends

TYPE: Plain bearings, Spherical plain bearings and rod ends, Rod ends, Requiring maintenance, With internal thread, open design, left hand thread, inch, series POSB..L

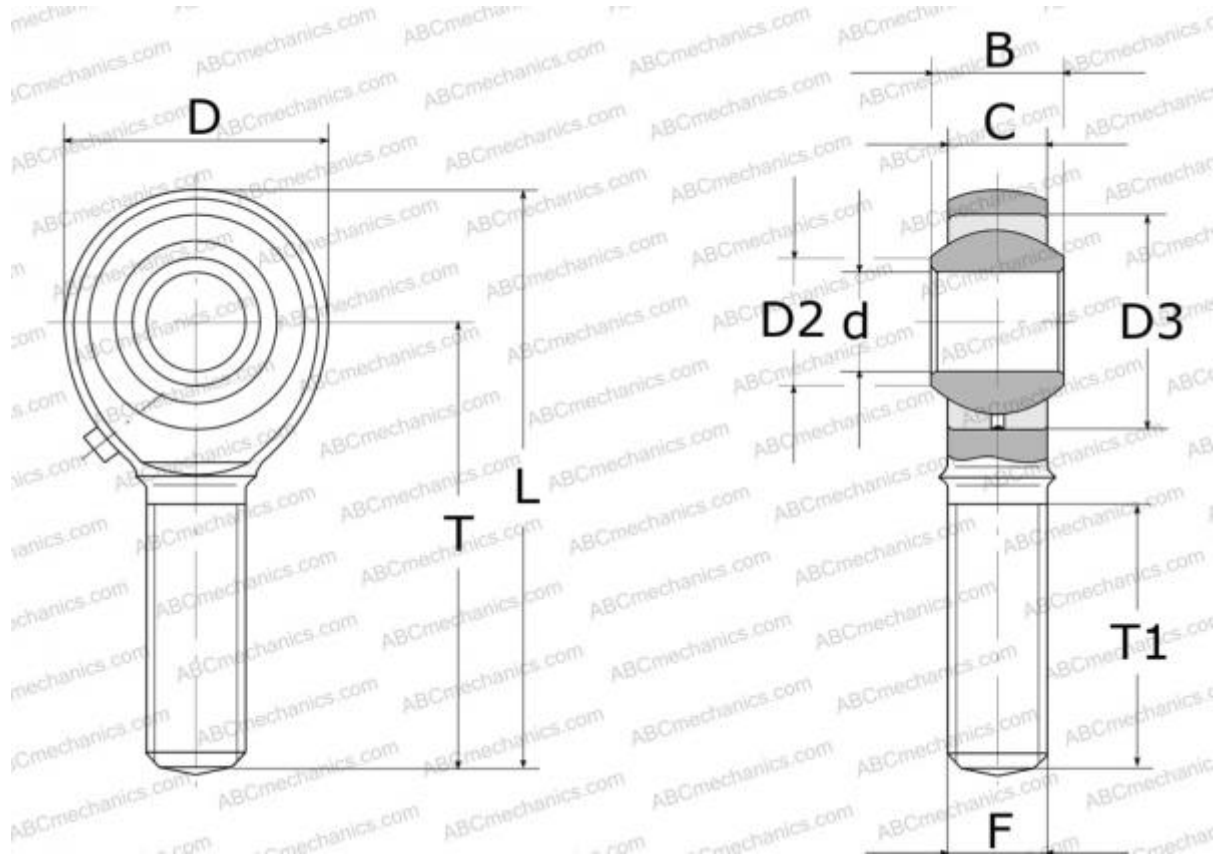

Technical specification

DIMENSIONS, MM

d	4,826
D	15,880
D2	7,770
B	7,920
L	39,700
T	31,750
T1	19,050
C	6,350
F	.1900-32UNF

WEIGHT, KG 0,013

MANUFACTURER [ABC](#)

INTERCHANGE

IKO [POSB 3 L](#)