

POSB 4 L IKO

Rod ends

TYPE: Plain bearings, Spherical plain bearings and rod ends, Rod ends, Requiring maintenance, With internal thread, open design, left hand thread, inch, series POSB..L

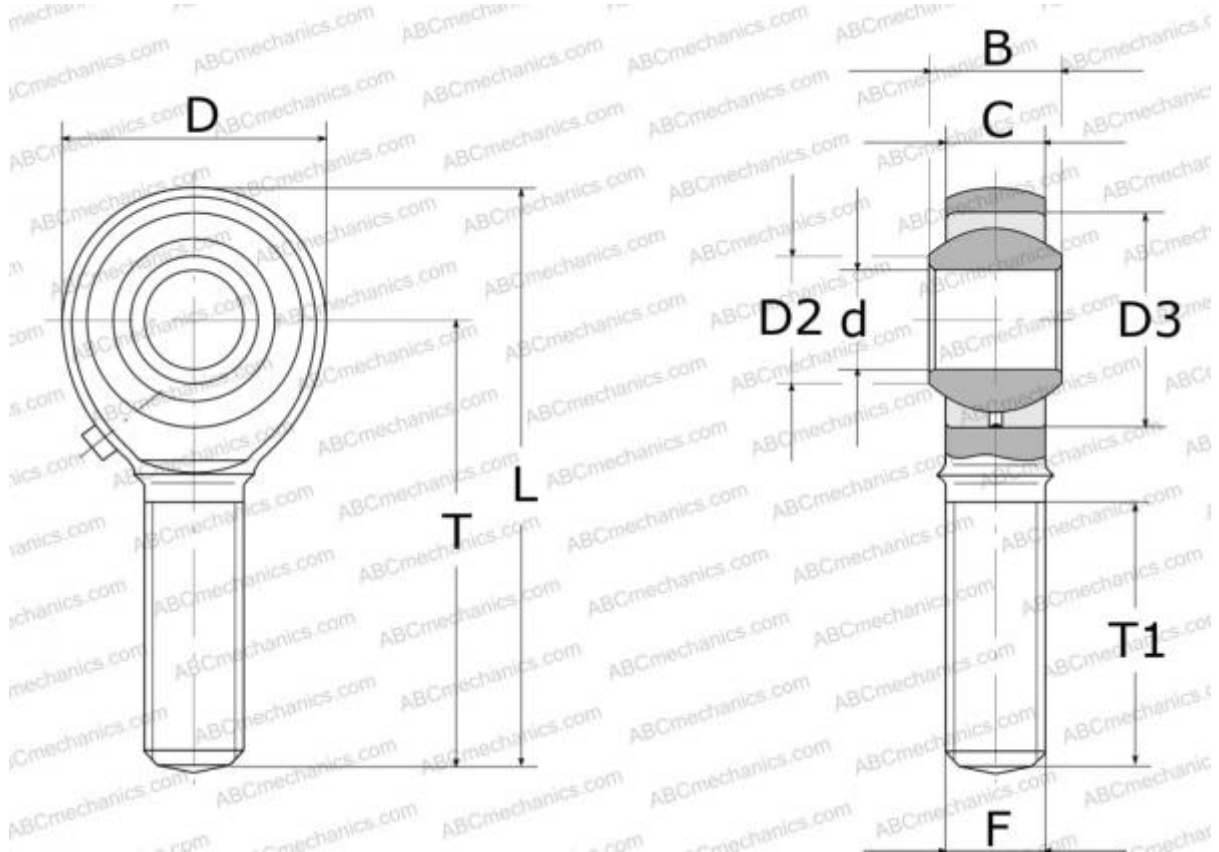

Technical specification

DIMENSIONS, MM

d	6,350
D	19,050
D2	9,020
B	9,530
L	49,200
T	39,670
T1	25,400
C	7,140
F	.2500-28UNF

WEIGHT, KG 0,022

MANUFACTURER [IKO](#)

INTERCHANGE

ABC [POSB 4 L](#)

CALCULATION DATA

Basic dynamic load rating, C	4,590 kN
Basic static load rating, Co	8,870 kN