

## PHS 3 EC IKO

Rod ends

TYPE: Plain bearings, Spherical plain bearings and rod ends, Rod ends, Maintenance free, With internal thread, open design, right hand thread, series PHS..EC, GIKR..PW, GIKPR..PW, SIKB

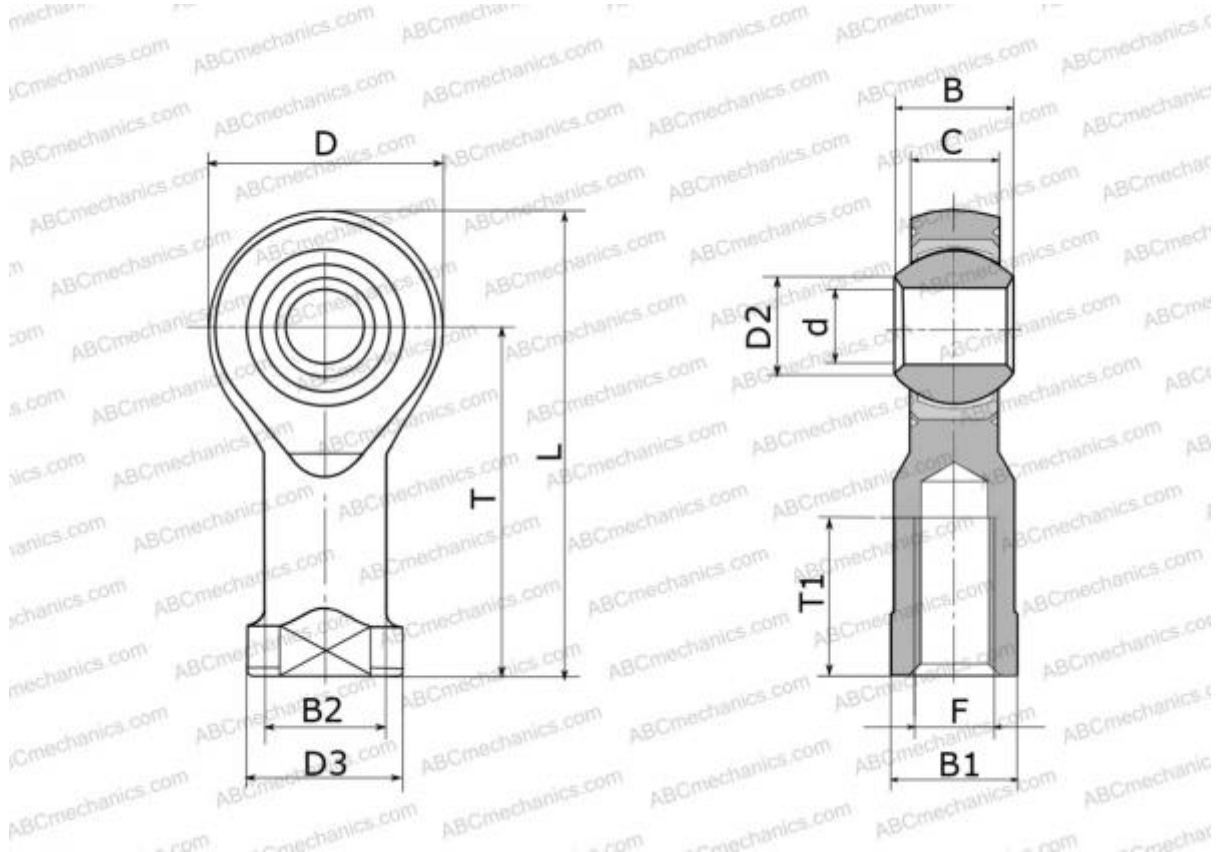

### Technical specification

#### DIMENSIONS, MM

d	3,000
D	12,000
D2	5,200
B	6,000
B1	5,500
L	27,000
T	21,000
T1	10,000
C	4,500
F	M3x0.5

**WEIGHT, KG** 0,006

**MANUFACTURER** [IKO](#)

#### INTERCHANGE

ABC	<a href="#">PHS 3 EC</a>
HEIM	<a href="#">SFE3</a>
AURORA	<a href="#">MW-M3T</a>

#### CALCULATION DATA

Basic dynamic load rating, C	3,500 kN
Basic static load rating, Co	2,480 kN