

PHS 5 EC IKO

Rod ends

TYPE: Plain bearings, Spherical plain bearings and rod ends, Rod ends, Maintenance free, With internal thread, open design, right hand thread, series PHS..EC, GIKR..PW, GIKPR..PW, SIKB

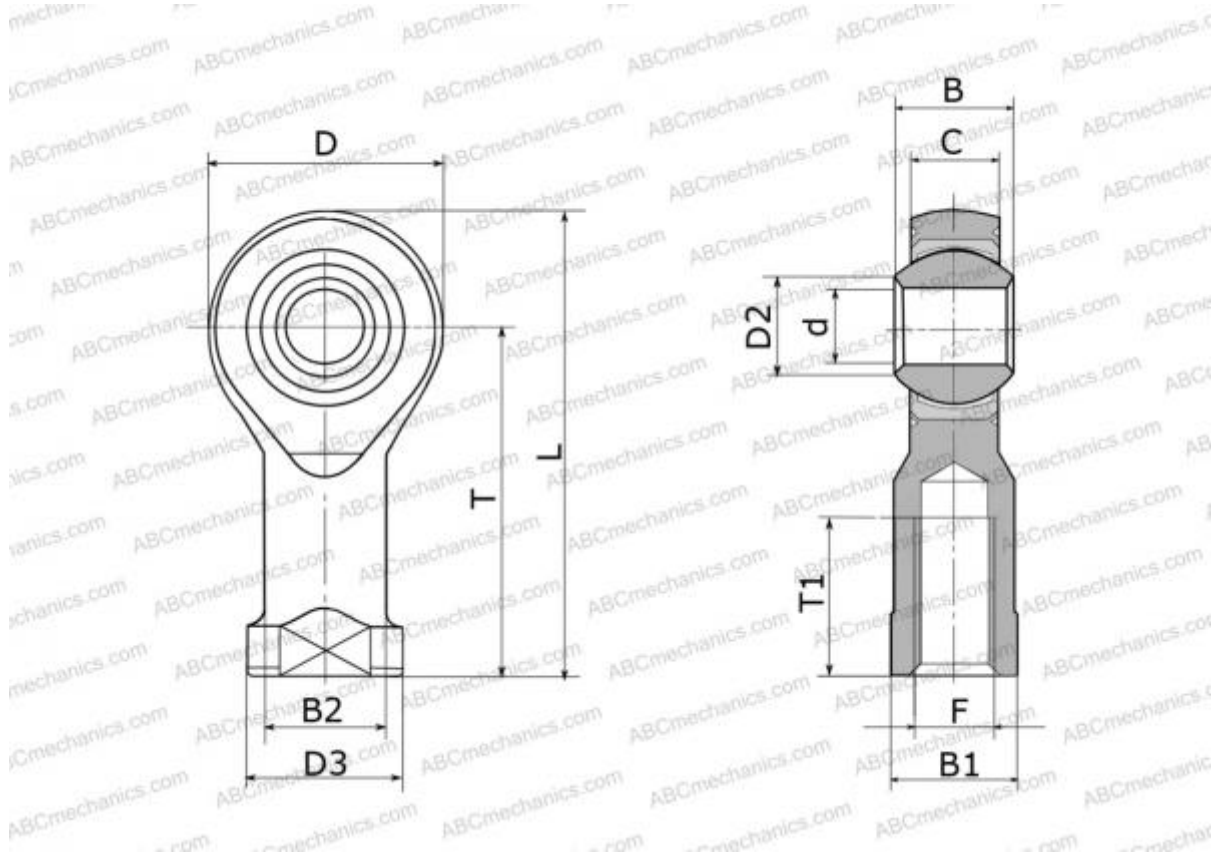

Technical specification

DIMENSIONS, MM

d	5,000
D	16,000
D2	7,700
B	8,000
B1	9,000
L	35,000
T	27,000
T1	12,500
C	6,000
F	M5x0.8

WEIGHT, KG 0,017

MANUFACTURER [IKO](#)

INTERCHANGE

ABC	PHS 5 EC
SKF	SIKB 5 F
HIRSCHMANN	SFCV 5
HEIM	SFE5
AURORA	MW-M5T

CALCULATION DATA

Basic dynamic load rating, C	6,540 kN
Basic static load rating, Co	4,010 kN