

PHS 4 ECL ABC

Rod ends

TYPE: Plain bearings, Spherical plain bearings and rod ends, Rod ends, Maintenance free, With internal thread, open design, left hand thread, series PHS..ECL, GIKL..PW, SILKB

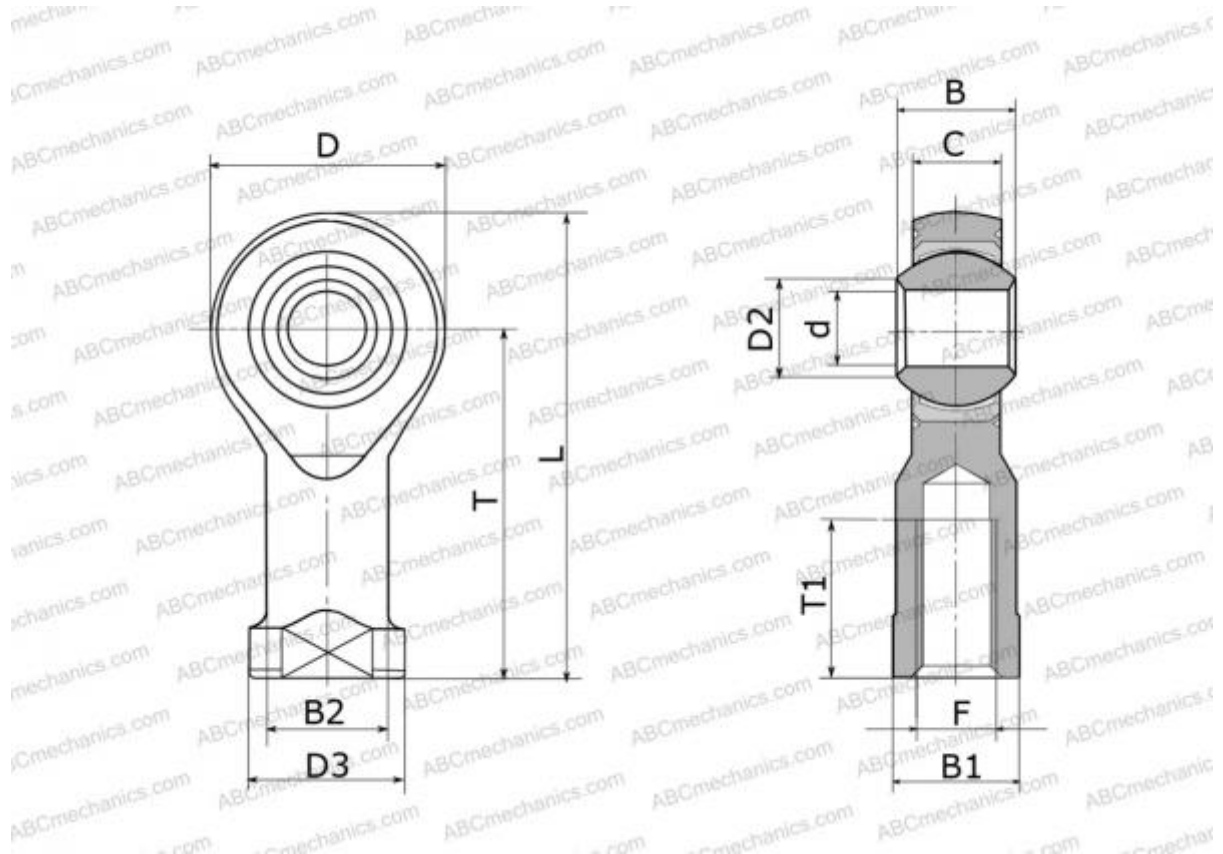

Technical specification

DIMENSIONS, MM

d	4,000
D	14,000
D2	6,500
B	7,000
B1	8,000
L	31,000
T	24,000
T1	12,000
C	5,300
F	M4x0.7

WEIGHT, KG 0,012

MANUFACTURER [ABC](#)

INTERCHANGE

IKO	PHS 4 ECL
HEIM	SFLE4
AURORA	MG-M4T