

PHSA 6 IKO

Rod ends

TYPE: Plain bearings, Spherical plain bearings and rod ends, Rod ends, Requiring maintenance, With internal thread, open design, right hand thread, series PHSA (IKO)

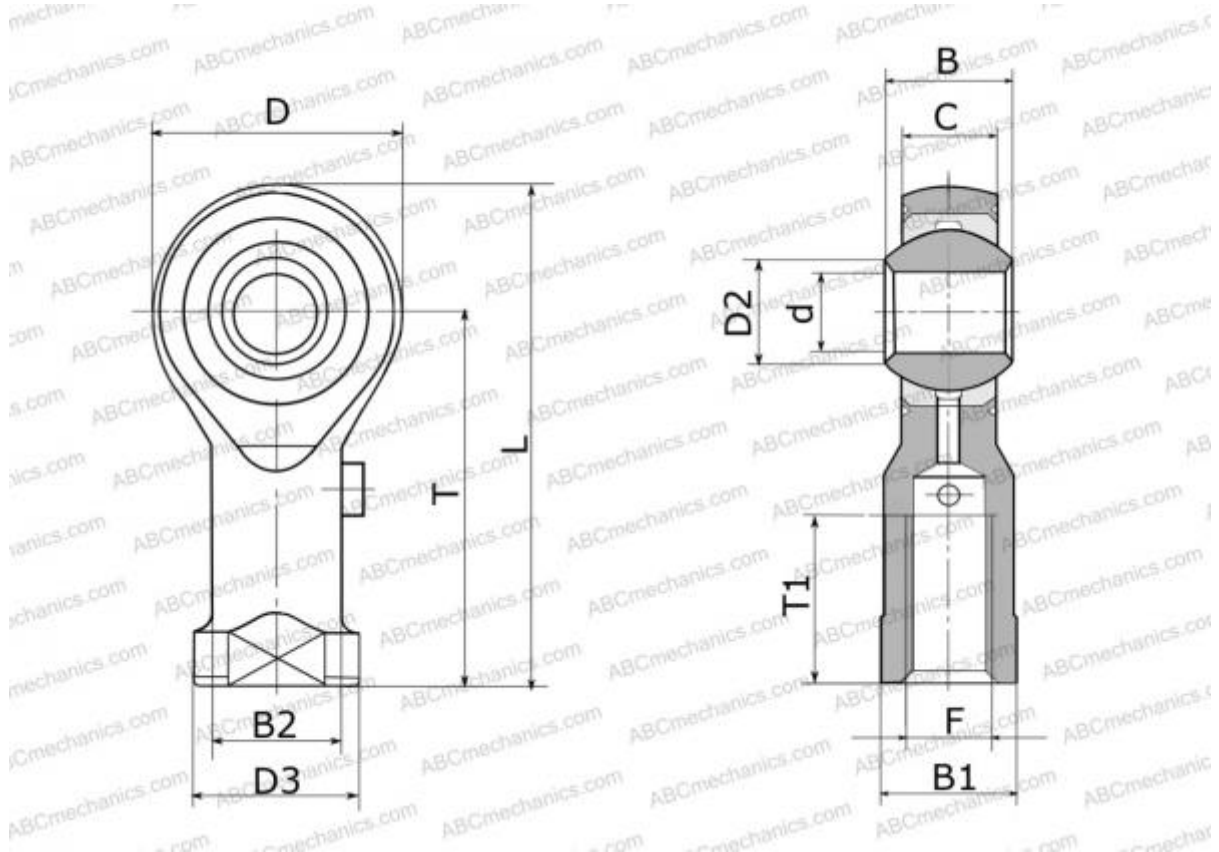

Technical specification

DIMENSIONS, MM

d	6,000
D	19,500
D2	9,000
B	9,000
L	39,700
T	30,000
T1	16,000
C	6,750
F	M6x1

WEIGHT, KG 0,025

MANUFACTURER [IKO](#)

CALCULATION DATA

Basic static load rating, Co 6,760 kN