

PHSA 8 L IKO

Rod ends

TYPE: Plain bearings, Spherical plain bearings and rod ends, Rod ends, Requiring maintenance, With internal thread, open design, left hand thread, series PHSA..L (IKO)

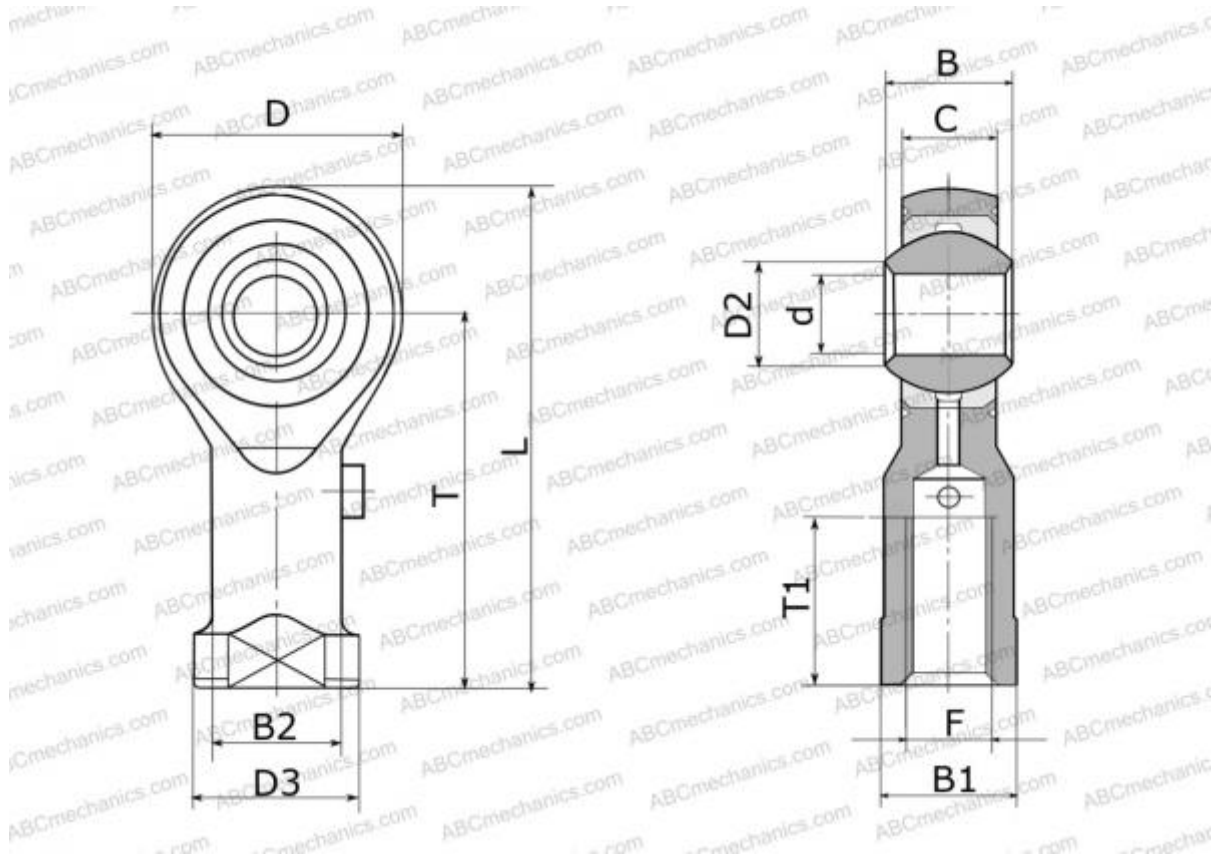

Technical specification

DIMENSIONS, MM

d	8,000
D	24,000
D2	10,400
B	12,000
L	48,000
T	36,000
T1	19,000
C	9,000
F	M8x1.25

WEIGHT, KG 0,045

MANUFACTURER [IKO](#)

CALCULATION DATA

Basic static load rating, Co 10,200 kN