

PHSA 16 L IKO

Rod ends

TYPE: Plain bearings, Spherical plain bearings and rod ends, Rod ends, Requiring maintenance, With internal thread, open design, left hand thread, series PHSA..L (IKO)

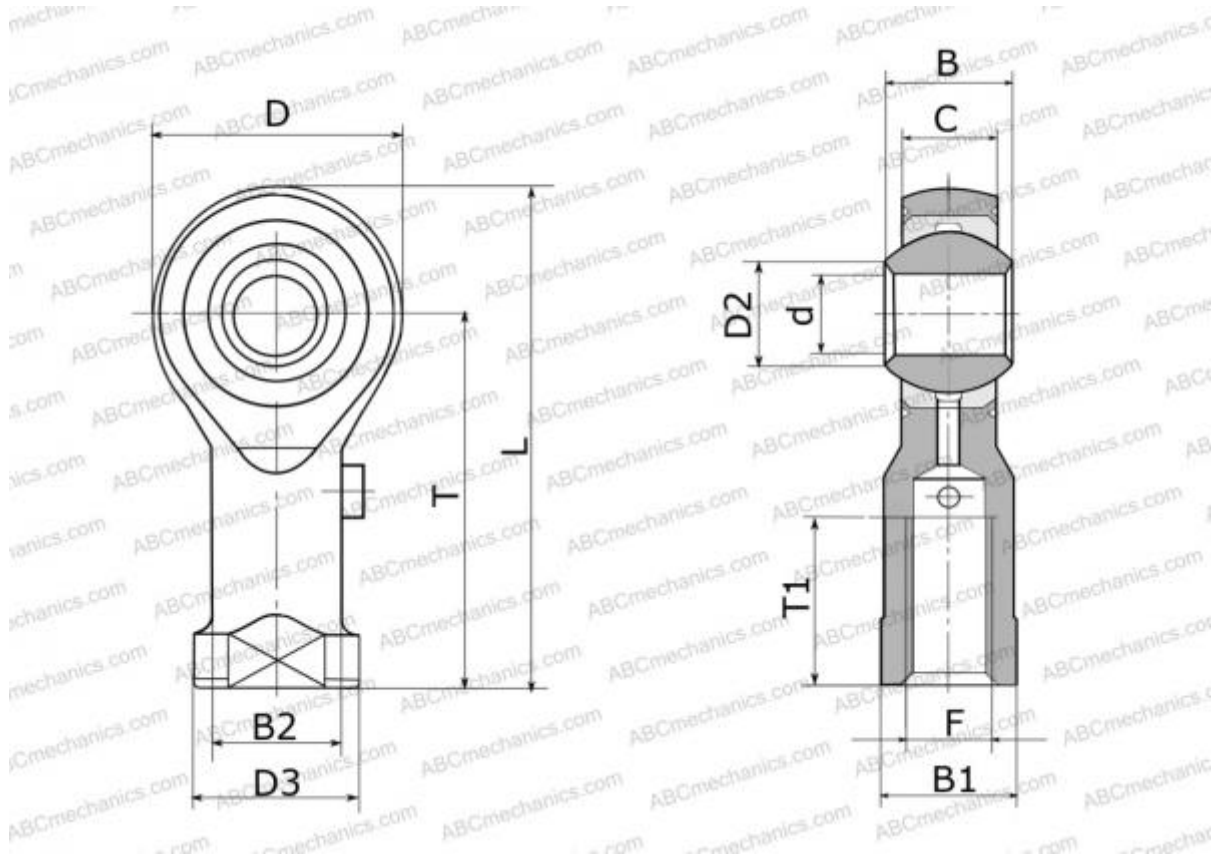

Technical specification

DIMENSIONS, MM

d	16,000
D	40,000
D2	19,400
B	21,000
L	84,000
T	64,000
T1	36,000
C	15,000
F	M16x2

WEIGHT, KG 0,190

MANUFACTURER [IKO](#)

CALCULATION DATA

Basic static load rating, Co 23,900 kN