

PHSA 20 L IKO

Rod ends

TYPE: Plain bearings, Spherical plain bearings and rod ends, Rod ends, Requiring maintenance, With internal thread, open design, left hand thread, series PHSA..L (IKO)

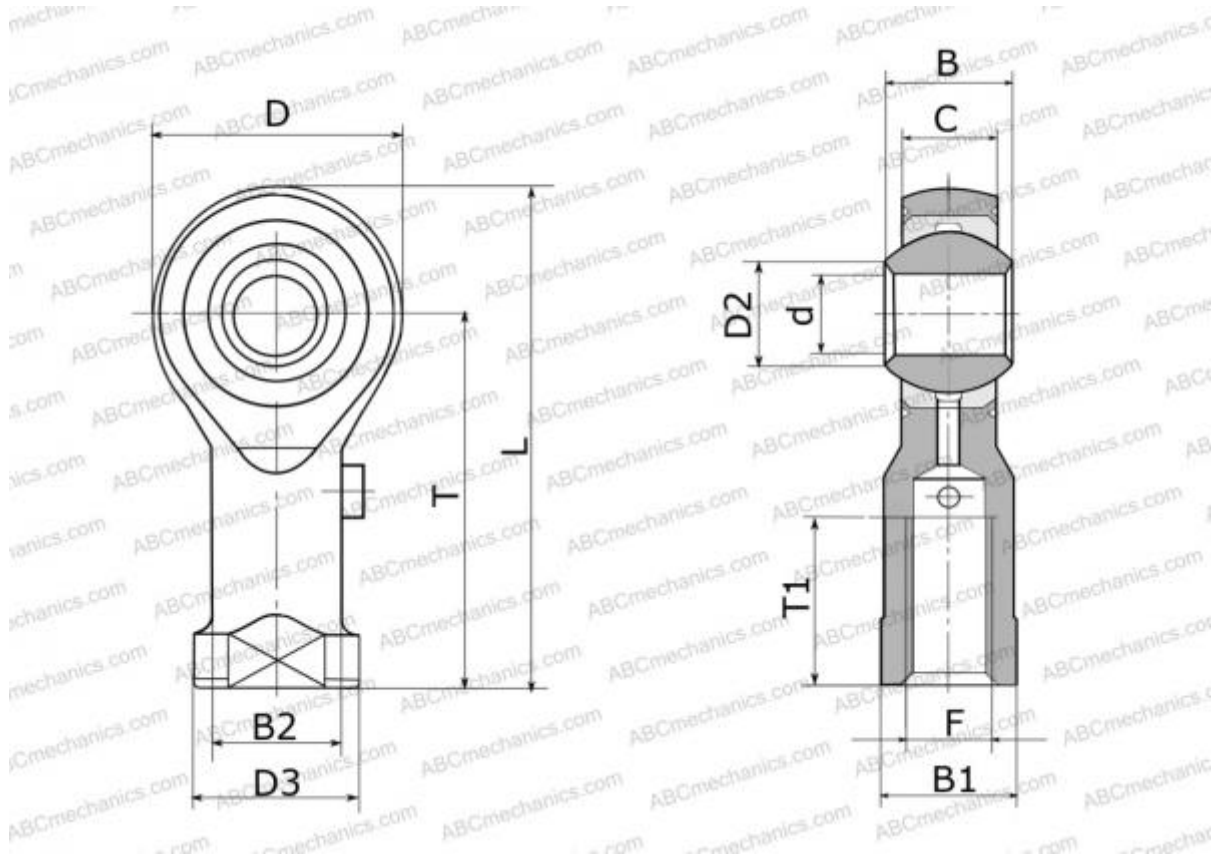

Technical specification

DIMENSIONS, MM

d	20,000
D	49,000
D2	24,400
B	25,000
L	101,500
T	77,000
T1	43,000
C	18,000
F	M20x1.5

WEIGHT, KG 0,400

MANUFACTURER [IKO](#)

CALCULATION DATA

Basic static load rating, Co 33,400 kN