

SI 6 C SKF

Rod ends

TYPE: Plain bearings, Spherical plain bearings and rod ends, Rod ends, Maintenance free, With internal thread, open design, right hand thread, series SI..C (SKF)

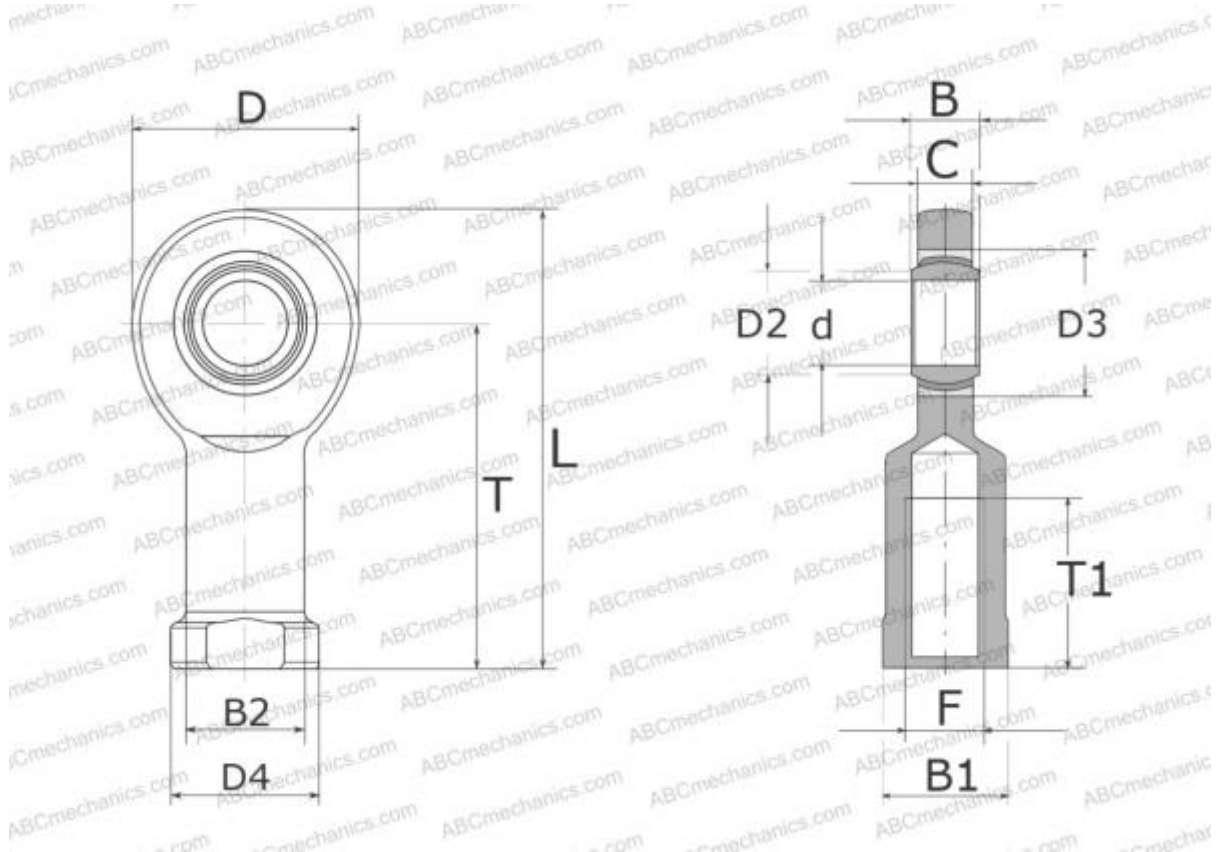

Technical specification

DIMENSIONS, MM

d	6,000
D	22,000
D4	11,000
B	6,000
B1	9,000
L	43,000
T	30,000
T1	11,000
C	4,500
F	M6

WEIGHT, KG 0,023

MANUFACTURER [SKF](http://www.skf.com)

CALCULATION DATA

Basic dynamic load rating, C	3,600 kN
Basic static load rating, Co	8,150 kN