

SI 12 C SKF

Rod ends

TYPE: Plain bearings, Spherical plain bearings and rod ends, Rod ends, Maintenance free, With internal thread, open design, right hand thread, series SI..C (SKF)

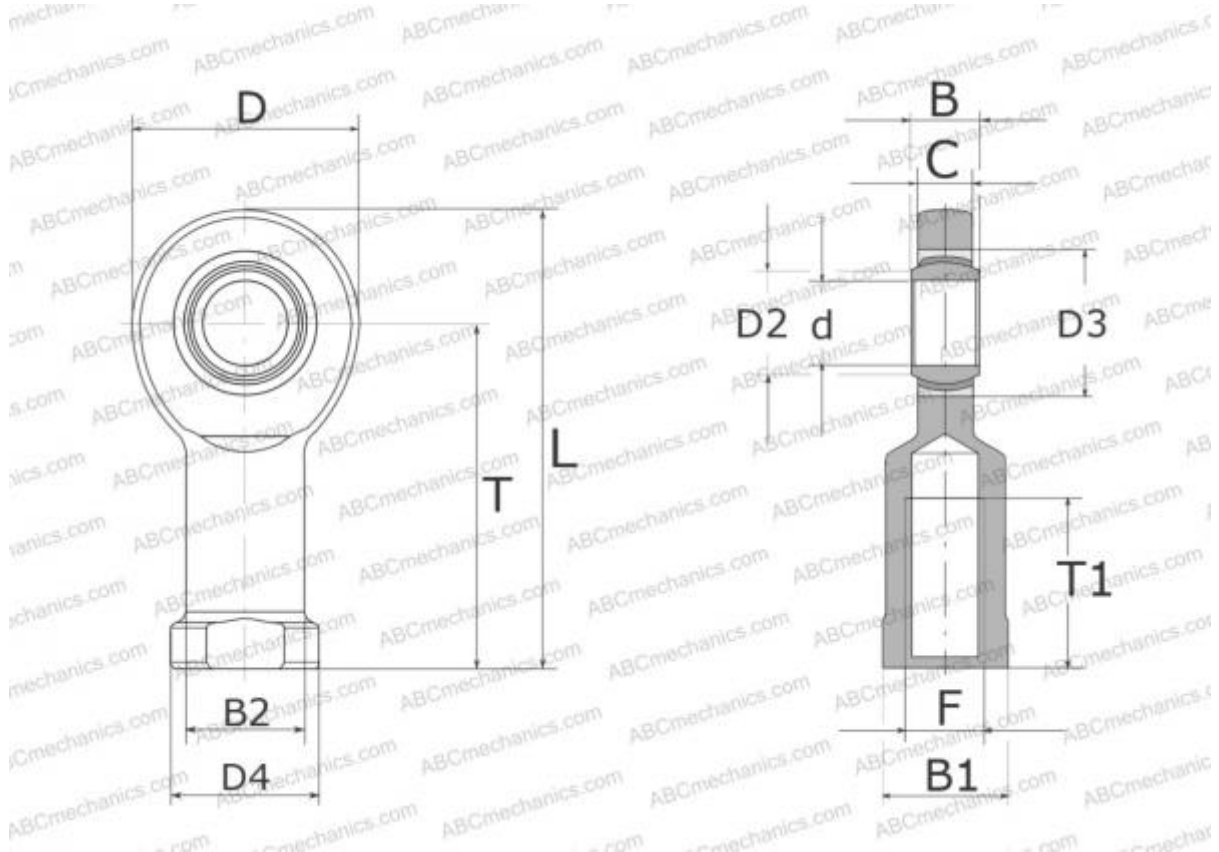

Technical specification

DIMENSIONS, MM

d	12,000
D	35,000
D4	19,000
B	10,000
B1	17,000
L	69,000
T	50,000
T1	18,000
C	8,500
F	M12

WEIGHT, KG 0,110

MANUFACTURER [SKF](#)

CALCULATION DATA

Basic dynamic load rating, C	11,400 kN
Basic static load rating, Co	25,500 kN