

SIL 8 C SKF

Rod ends

TYPE: Plain bearings, Spherical plain bearings and rod ends, Rod ends, Maintenance free, With internal thread, open design, left hand thread, series SIL..C (SKF)

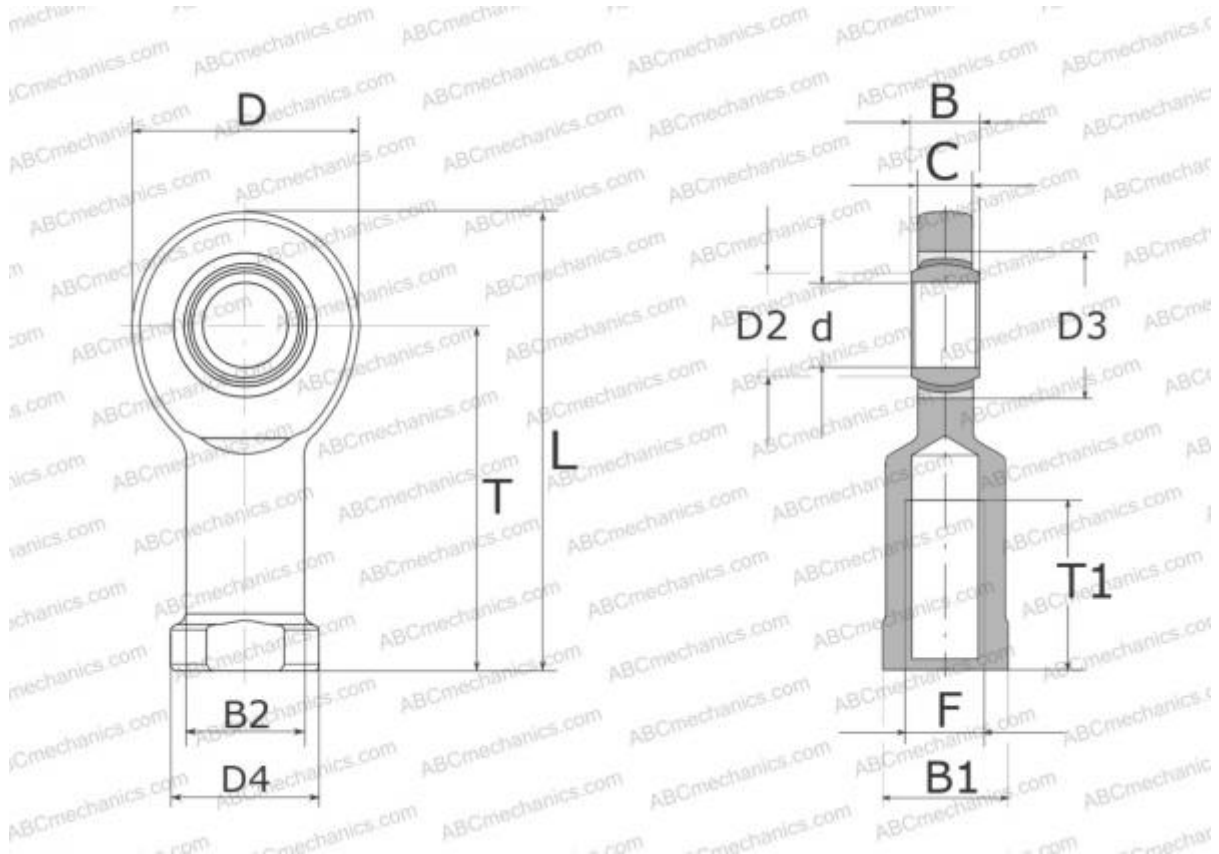

Technical specification

DIMENSIONS, MM

d	8,000
D	25,000
D4	13,000
B	8,000
B1	11,000
L	50,000
T	36,000
T1	15,000
C	6,500
F	M8

WEIGHT, KG 0,036

MANUFACTURER [SKF](#)

CALCULATION DATA

Basic dynamic load rating, C	5,800 kN
Basic static load rating, Co	12,900 kN