

SA 6 C SKF

Rod ends

TYPE: Plain bearings, Spherical plain bearings and rod ends, Rod ends, Maintenance free, With external thread, open design, right hand thread, series SA..C (SKF)

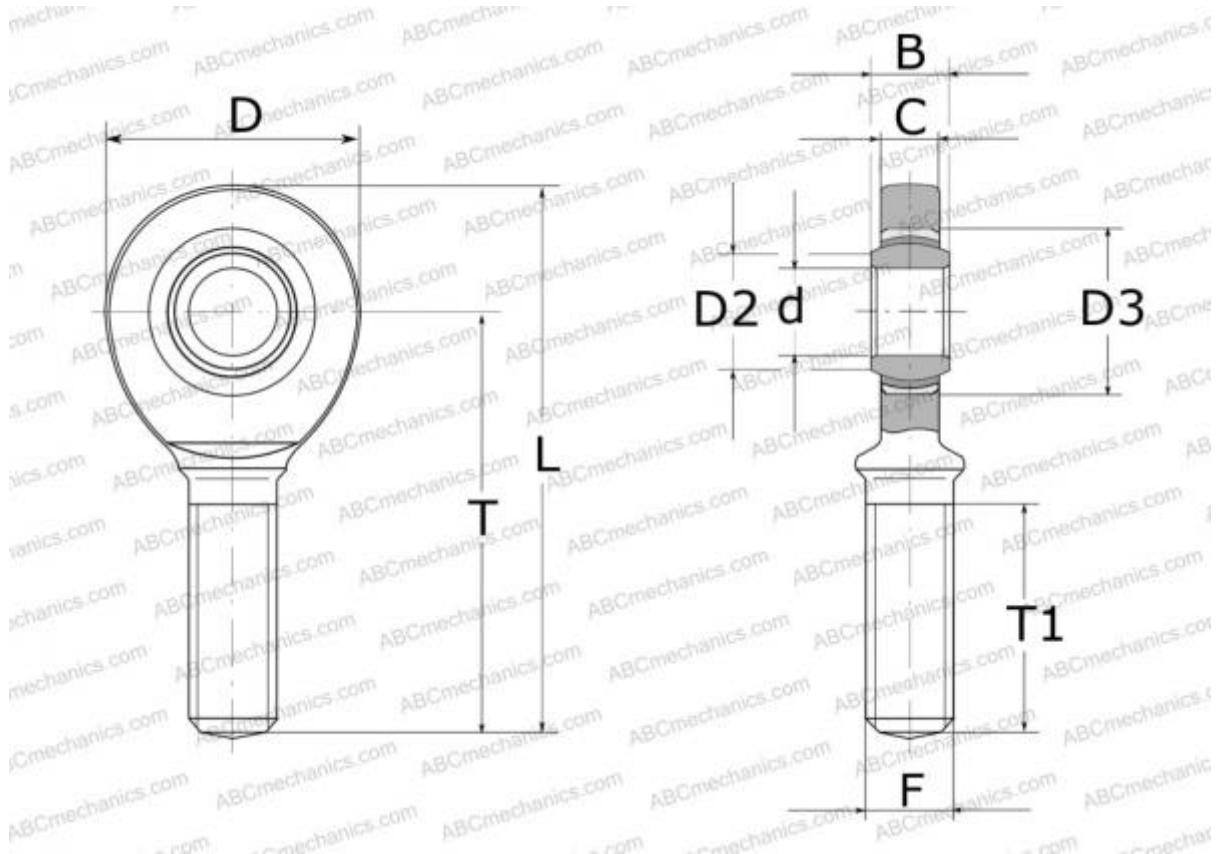

Technical specification

DIMENSIONS, MM

d	6,000
D	22,000
B	6,000
L	49,000
T	36,000
T1	16,000
C	4,500
F	M6

WEIGHT, KG 0,017

MANUFACTURER [SKF](#)

CALCULATION DATA

Basic dynamic load rating, C	3,600 kN
Basic static load rating, Co	8,150 kN