

SA 8 C SKF

Rod ends

TYPE: Plain bearings, Spherical plain bearings and rod ends, Rod ends, Maintenance free, With external thread, open design, right hand thread, series SA..C (SKF)

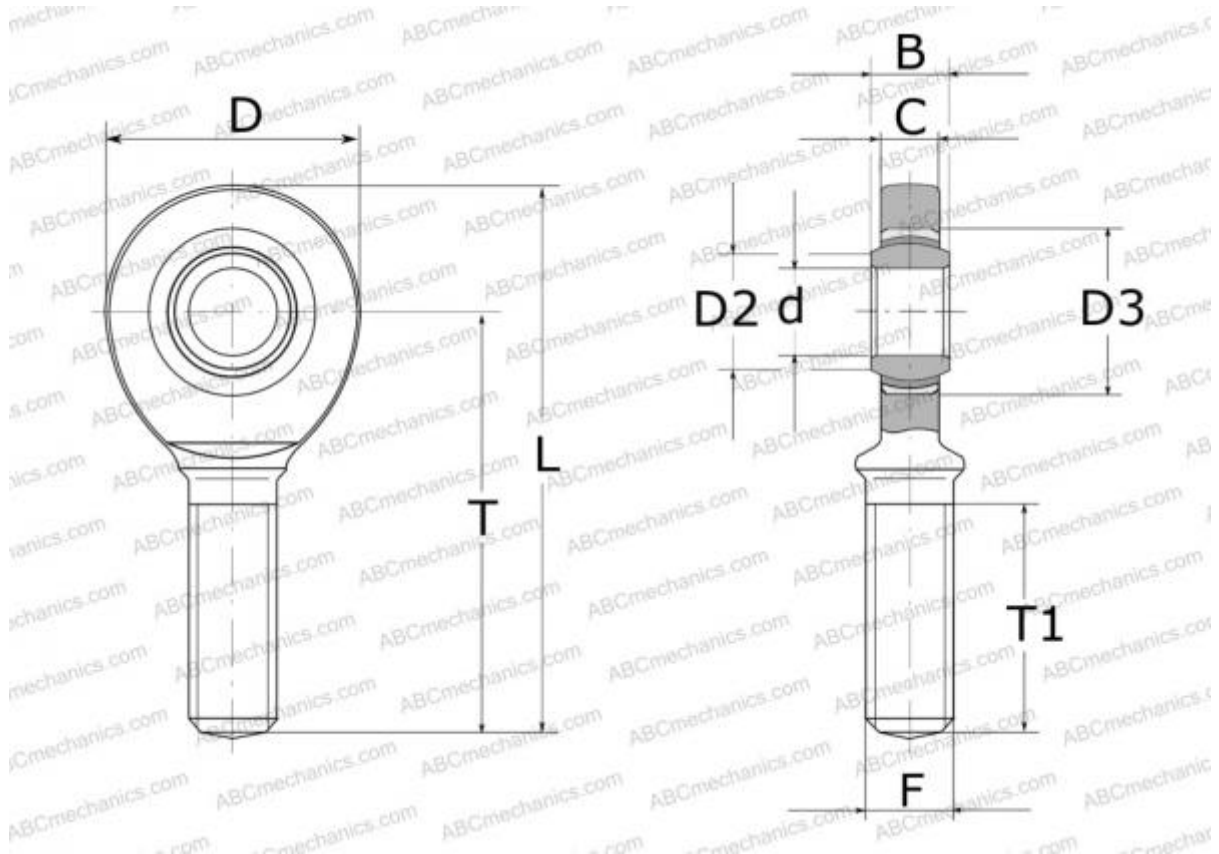

Technical specification

DIMENSIONS, MM

d	8,000
D	25,000
B	8,000
L	56,000
T	42,000
T1	21,000
C	6,500
F	M8

WEIGHT, KG 0,030

MANUFACTURER [SKF](#)

CALCULATION DATA

Basic dynamic load rating, C	5,850 kN
Basic static load rating, Co	12,900 kN