

SA 10 C SKF

Rod ends

TYPE: Plain bearings, Spherical plain bearings and rod ends, Rod ends, Maintenance free, With external thread, open design, right hand thread, series SA..C (SKF)

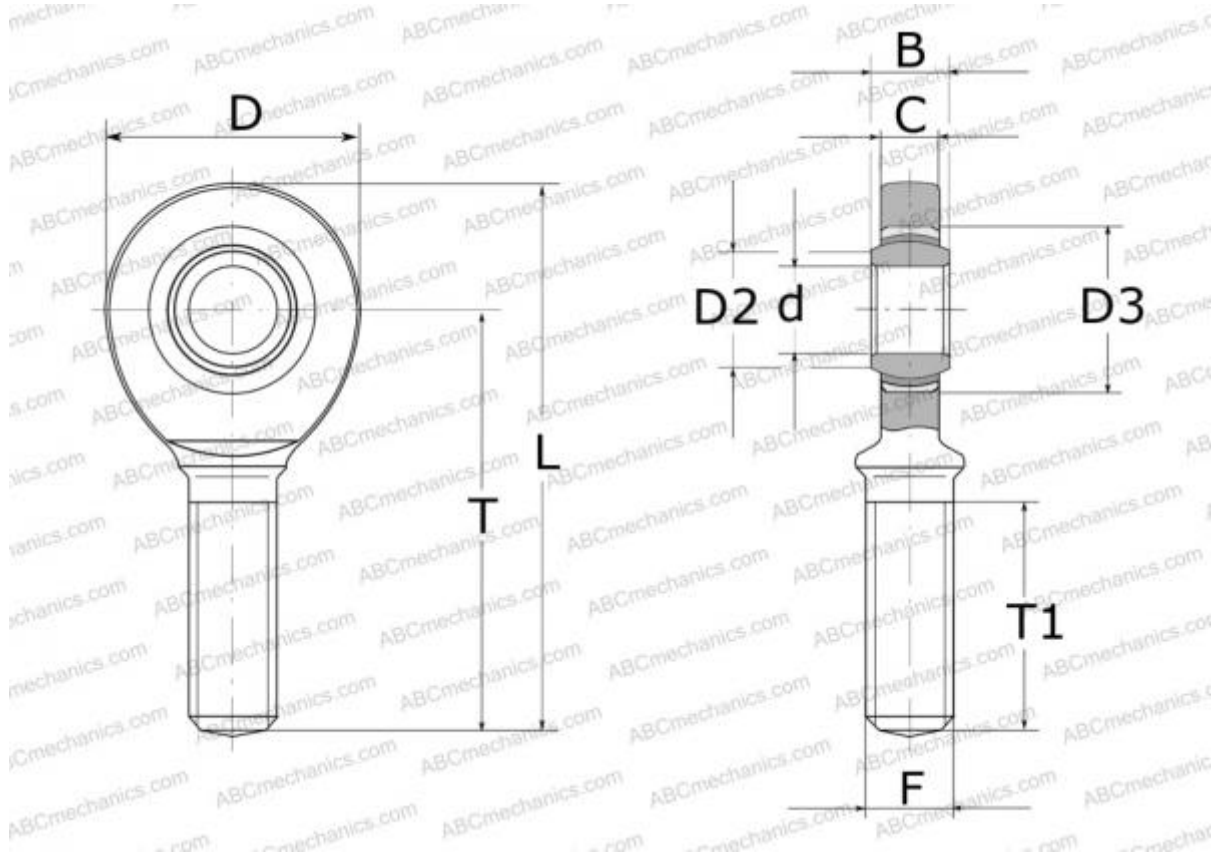

Technical specification

DIMENSIONS, MM

d	10,000
D	30,000
B	9,000
L	65,000
T	48,000
T1	26,000
C	7,500
F	M10

WEIGHT, KG 0,053

MANUFACTURER [SKF](#)

CALCULATION DATA

Basic dynamic load rating, C	8,650 kN
Basic static load rating, Co	18,300 kN