

## SILA 40 TXE-2LS SKF

Rod ends

TYPE: Plain bearings, Spherical plain bearings and rod ends, Rod ends, Maintenance free, With internal thread, open design, left hand thread, series SIL(A)..TXE-2LS (SKF)

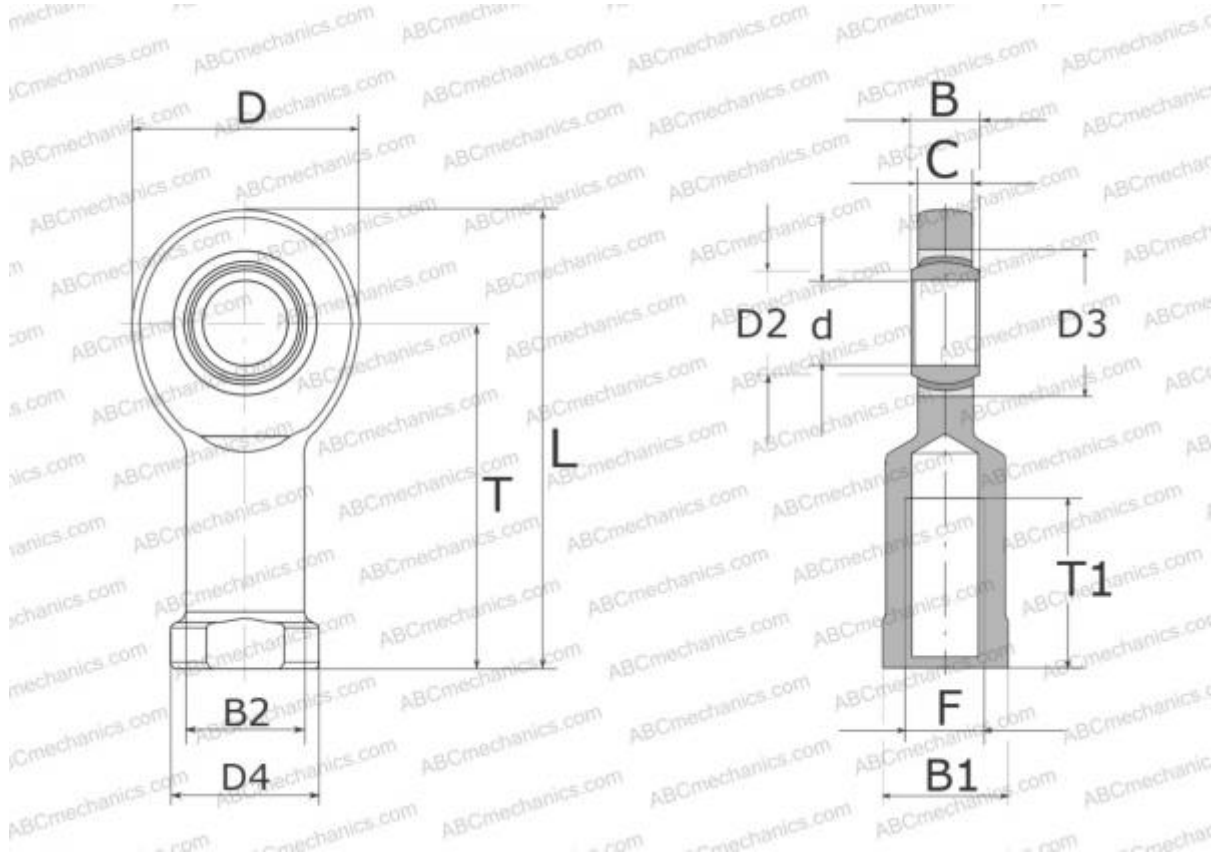

### Technical specification

#### DIMENSIONS, MM

d	40,000
D	94,000
D4	58,000
B	28,000
B1	50,000
L	191,000
T	142,000
T1	65,000
C	24,000
F	M39x3

**WEIGHT, KG** 2,200

**MANUFACTURER** [SKF](https://www.skf.com)

#### CALCULATION DATA

Basic dynamic load rating, C	280,000 kN
Basic static load rating, Co	166,000 kN