

## SILA 60 TXE-2LS SKF

Rod ends

TYPE: Plain bearings, Spherical plain bearings and rod ends, Rod ends, Maintenance free, With internal thread, open design, left hand thread, series SIL(A)..TXE-2LS (SKF)

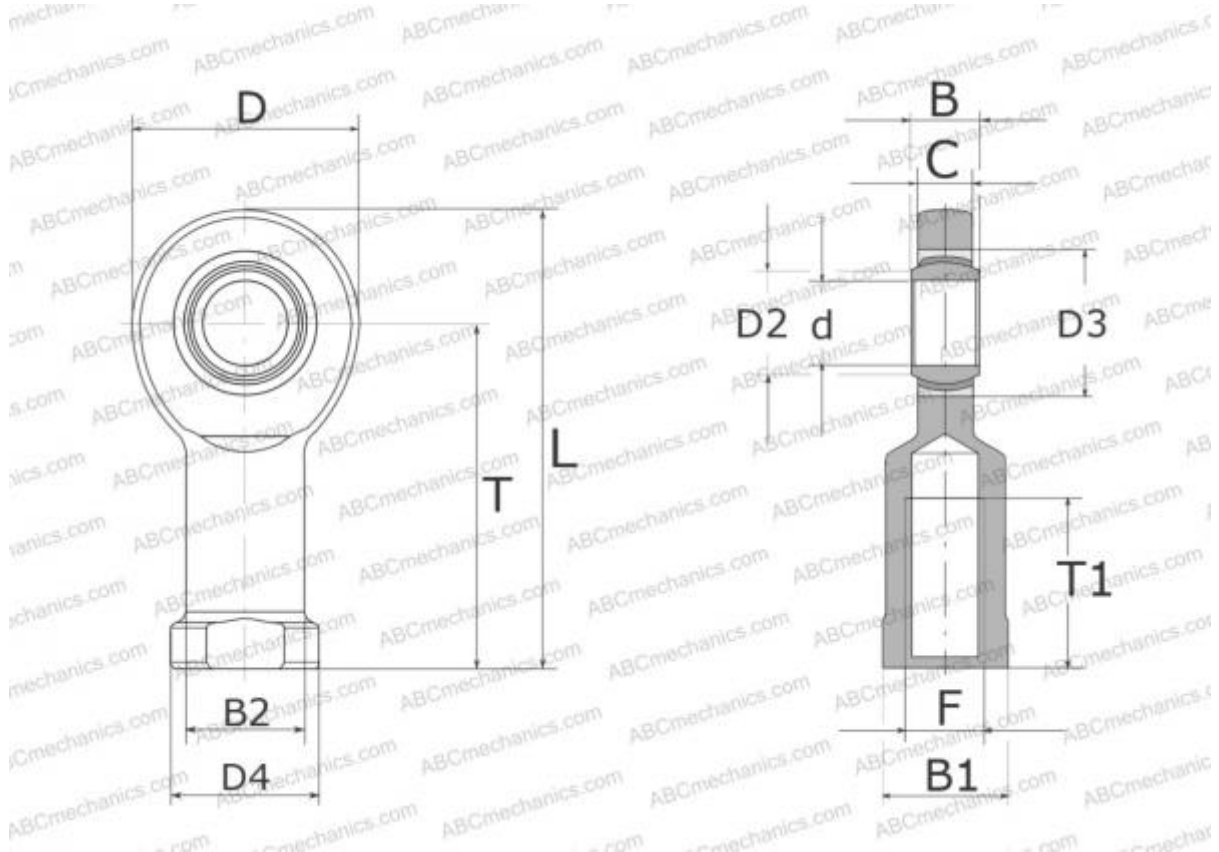

### Technical specification

#### DIMENSIONS, MM

d	60,000
D	137,000
D4	82,000
B	44,000
B1	70,000
L	246,000
T	175,000
T1	70,000
C	39,000
F	M52x3

**WEIGHT, KG** 6,300

**MANUFACTURER** [SKF](https://www.skf.com)

#### CALCULATION DATA

Basic dynamic load rating, C	695,000 kN
Basic static load rating, Co	400,000 kN