

SAA 60 TXE-2LS SKF

Rod ends

TYPE: Plain bearings, Spherical plain bearings and rod ends, Rod ends, Maintenance free, With external thread, open design, right hand thread, series SA(A)..TXE-2LS

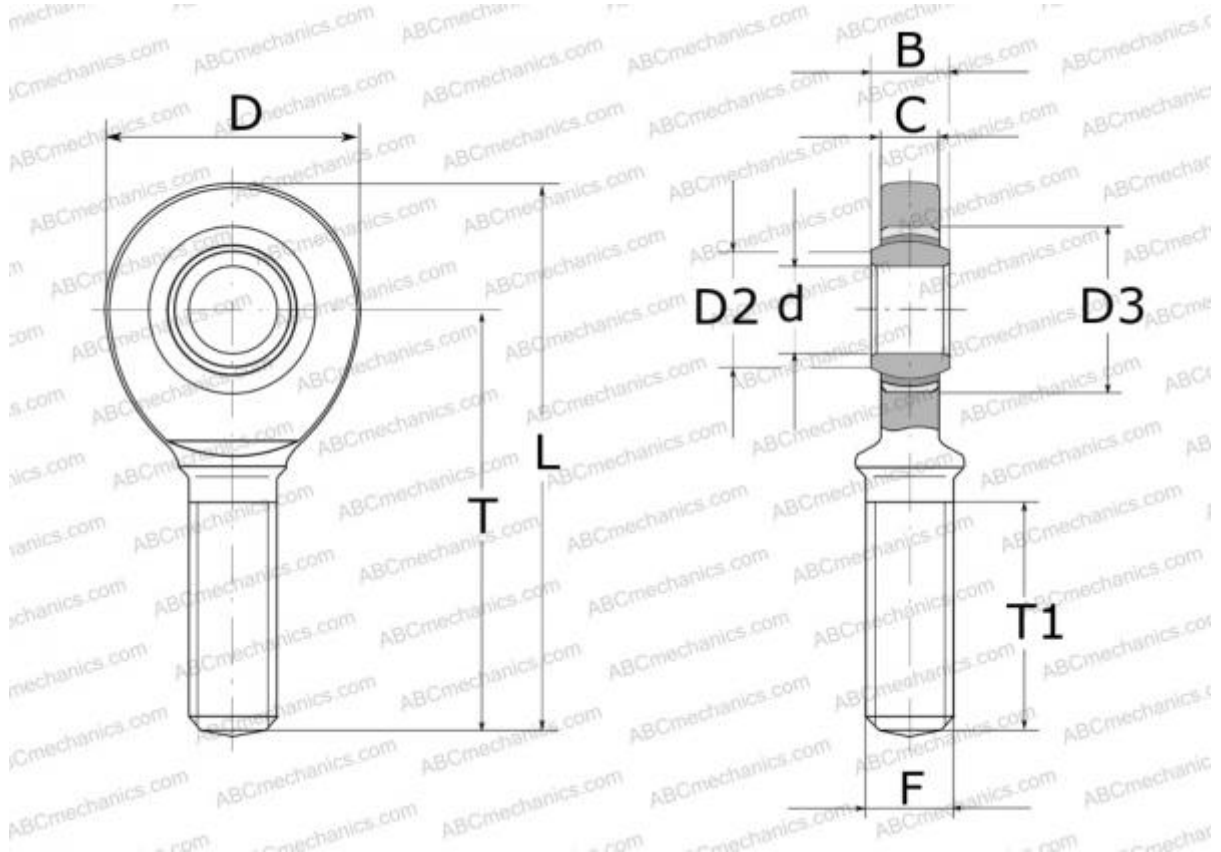

Technical specification

DIMENSIONS, MM

d	60,000
D	137,000
B	44,000
L	281,000
T	210,000
T1	115,000
C	39,000
F	M52x3

WEIGHT, KG 5,700

MANUFACTURER [SKF](#)

CALCULATION DATA

Basic dynamic load rating, C	695,000 kN
Basic static load rating, Co	360,000 kN