

SALA 45 TXE-2LS SKF

Rod ends

TYPE: Plain bearings, Spherical plain bearings and rod ends, Rod ends, Maintenance free, With external thread, open design, left hand thread, series SAL(A)..TXE-2LS

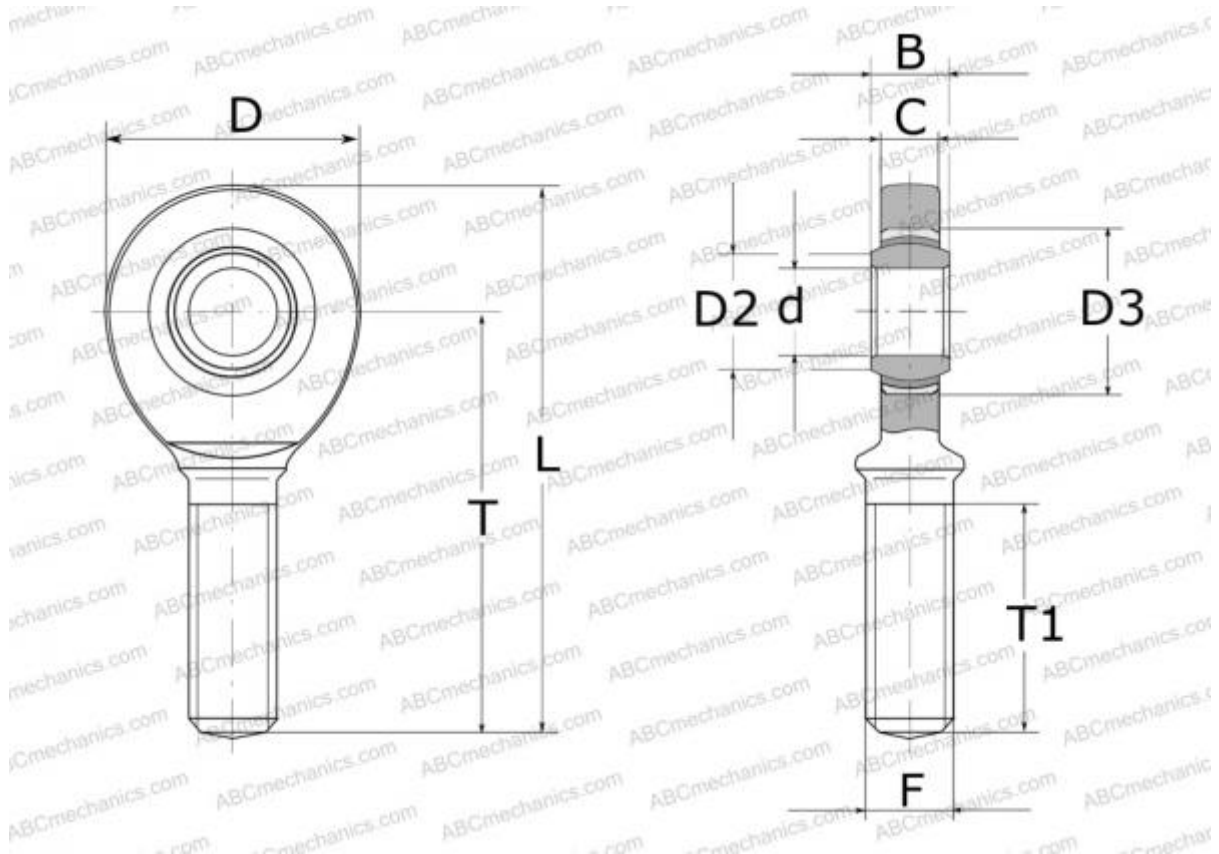

Technical specification

DIMENSIONS, MM

d	45,000
D	104,000
B	32,000
L	217,000
T	163,000
T1	92,000
C	28,000
F	M42x3

WEIGHT, KG 2,450

MANUFACTURER [SKF](#)

CALCULATION DATA

Basic dynamic load rating, C	360,000 kN
Basic static load rating, Co	200,000 kN