

SI 25 ES SKF

Rod ends

TYPE: Plain bearings, Spherical plain bearings and rod ends, Rod ends, Requiring maintenance, With internal thread, open design, right hand thread, series SI..E(S) (SKF)

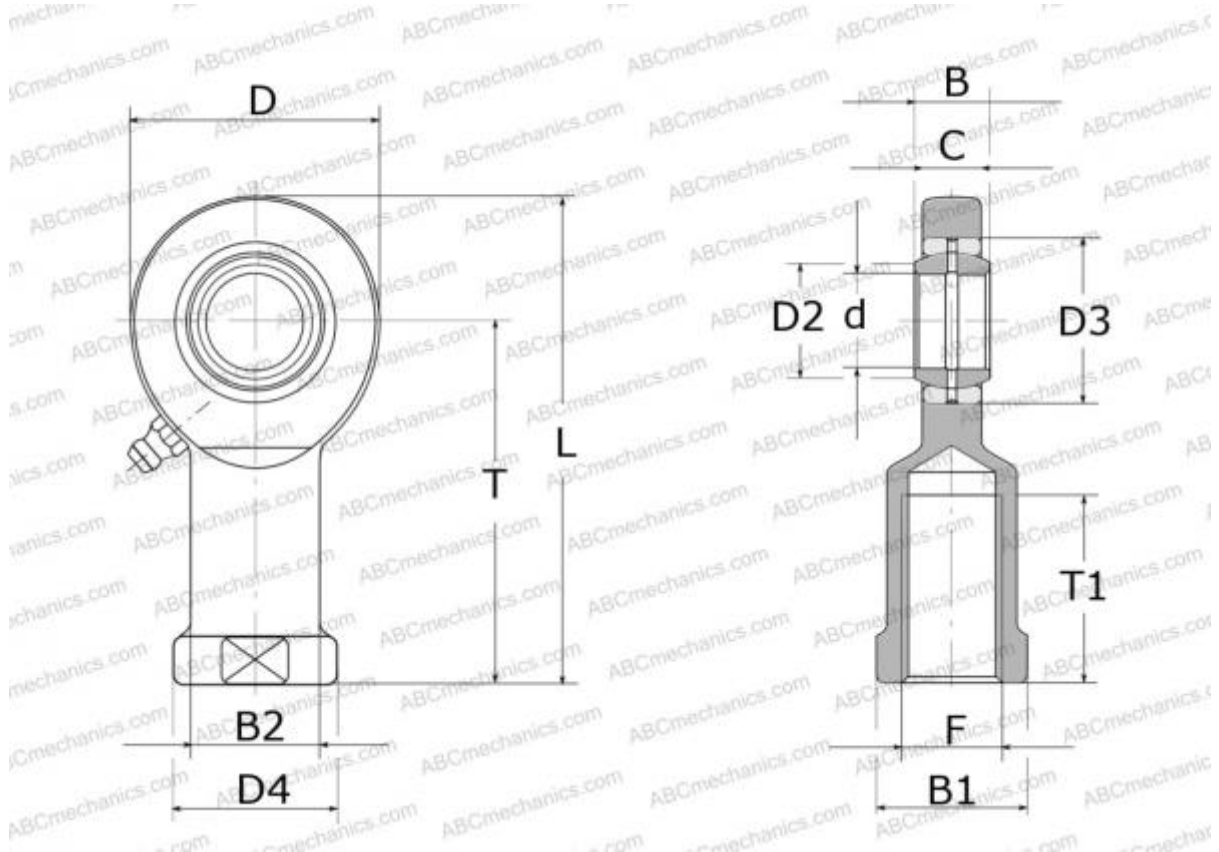

Technical specification

DIMENSIONS, MM

d	25,000
D	65,000
D4	35,000
B	20,000
B1	30,000
L	128,000
T	94,000
T1	36,000
C	18,000
F	M24x2

WEIGHT, KG 0,650

MANUFACTURER [SKF](#)

CALCULATION DATA

Basic dynamic load rating, C	48,000 kN
Basic static load rating, Co	90,000 kN