

SIA 40 ES-2RS SKF

Rod ends

TYPE: Plain bearings, Spherical plain bearings and rod ends, Rod ends, Requiring maintenance, With internal thread, with lip seals or high performance seals, right hand thread, series SI(A)..ES-2RS (SKF)

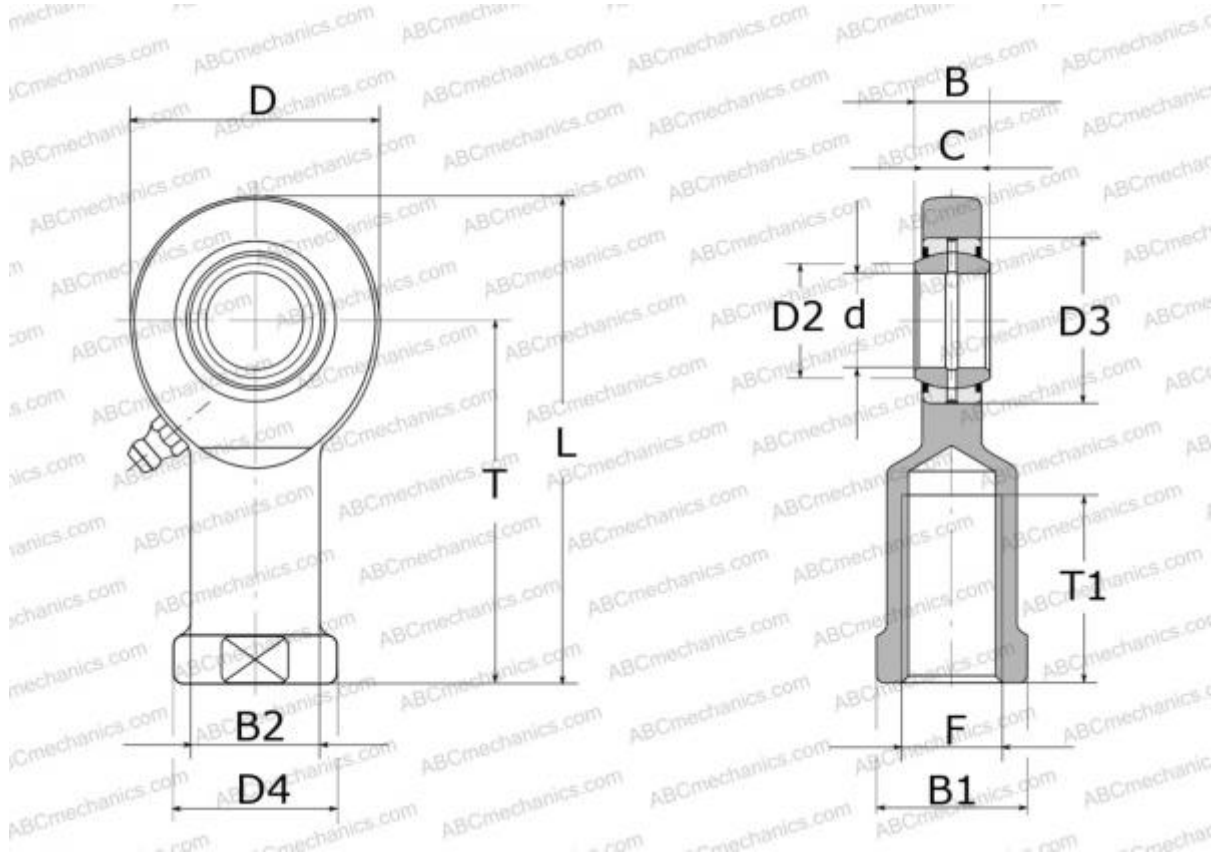

Technical specification

DIMENSIONS, MM

d	40,000
D	94,000
D4	58,000
B	28,000
B1	50,000
L	191,000
T	142,000
T1	65,000
C	24,000
F	M39x3

WEIGHT, KG 2,200

MANUFACTURER [SKF](https://www.skf.com)

CALCULATION DATA

Basic dynamic load rating, C	100,000 kN
Basic static load rating, Co	166,000 kN