

SIA 70 ES-2RS SKF

Rod ends

TYPE: Plain bearings, Spherical plain bearings and rod ends, Rod ends, Requiring maintenance, With internal thread, with lip seals or high performance seals, right hand thread, series SI(A)..ES-2RS (SKF)

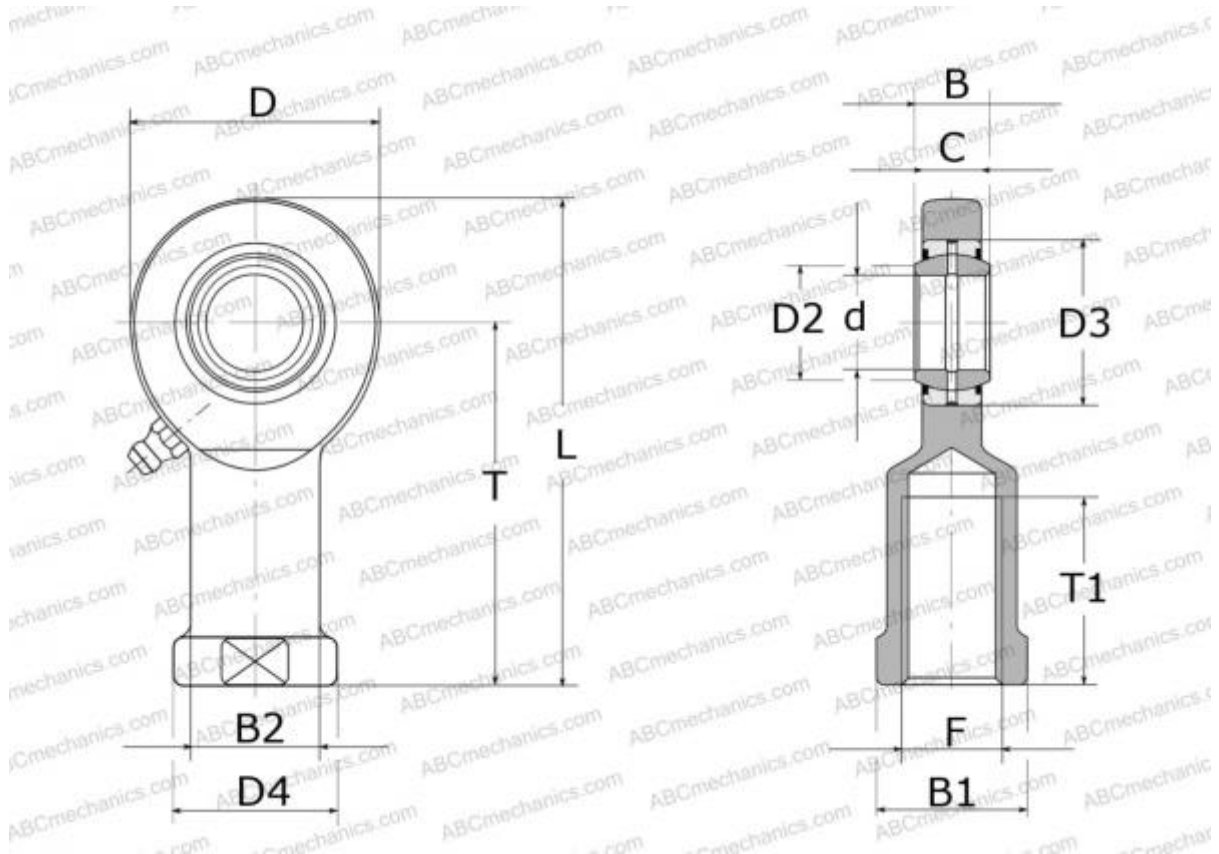

Technical specification

DIMENSIONS, MM

d	70,000
D	162,000
D4	92,000
B	49,000
B1	80,000
L	284,000
T	200,000
T1	80,000
C	43,000
F	M56x4

WEIGHT, KG 9,500

MANUFACTURER [SKF](https://www.skf.com)

CALCULATION DATA

Basic dynamic load rating, C	315,000 kN
Basic static load rating, Co	530,000 kN