

## SILA 50 ES-2RS SKF

Rod ends

TYPE: Plain bearings, Spherical plain bearings and rod ends, Rod ends, Requiring maintenance, With internal thread, with lip seals or high performance seals, left hand thread, series SIL(A)..ES-2RS (SKF)

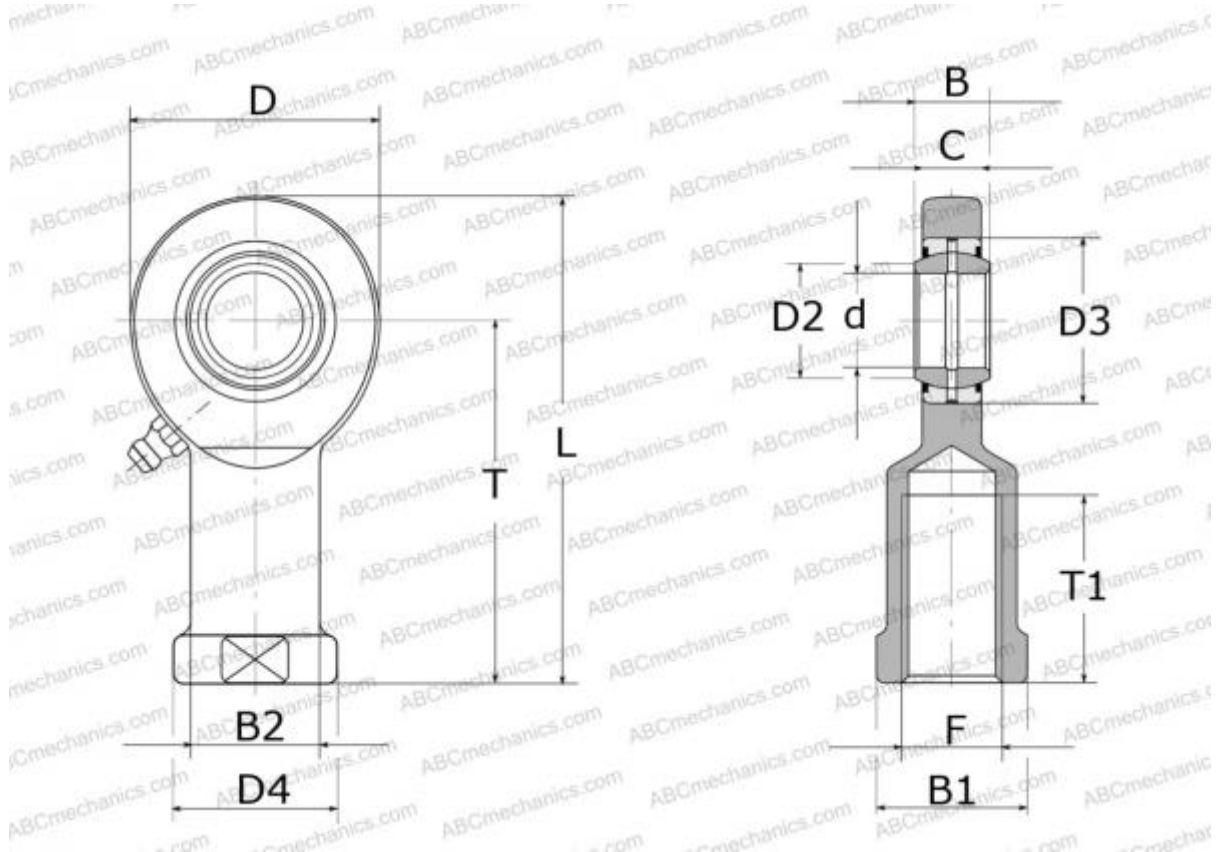

### Technical specification

#### DIMENSIONS, MM

d	50,000
D	114,000
D4	70,000
B	35,000
B1	60,000
L	219,000
T	160,000
T1	68,000
C	31,000
F	M45x3

**WEIGHT, KG** 4,100

**MANUFACTURER** [SKF](https://www.skf.com)

#### CALCULATION DATA

Basic dynamic load rating, C	156,000 kN
Basic static load rating, Co	270,000 kN