

SIL 60 ES-2RS SKF

Rod ends

TYPE: Plain bearings, Spherical plain bearings and rod ends, Rod ends, Requiring maintenance, With internal thread, with lip seals or high performance seals, left hand thread, series SIL(A)..ES-2RS (SKF)

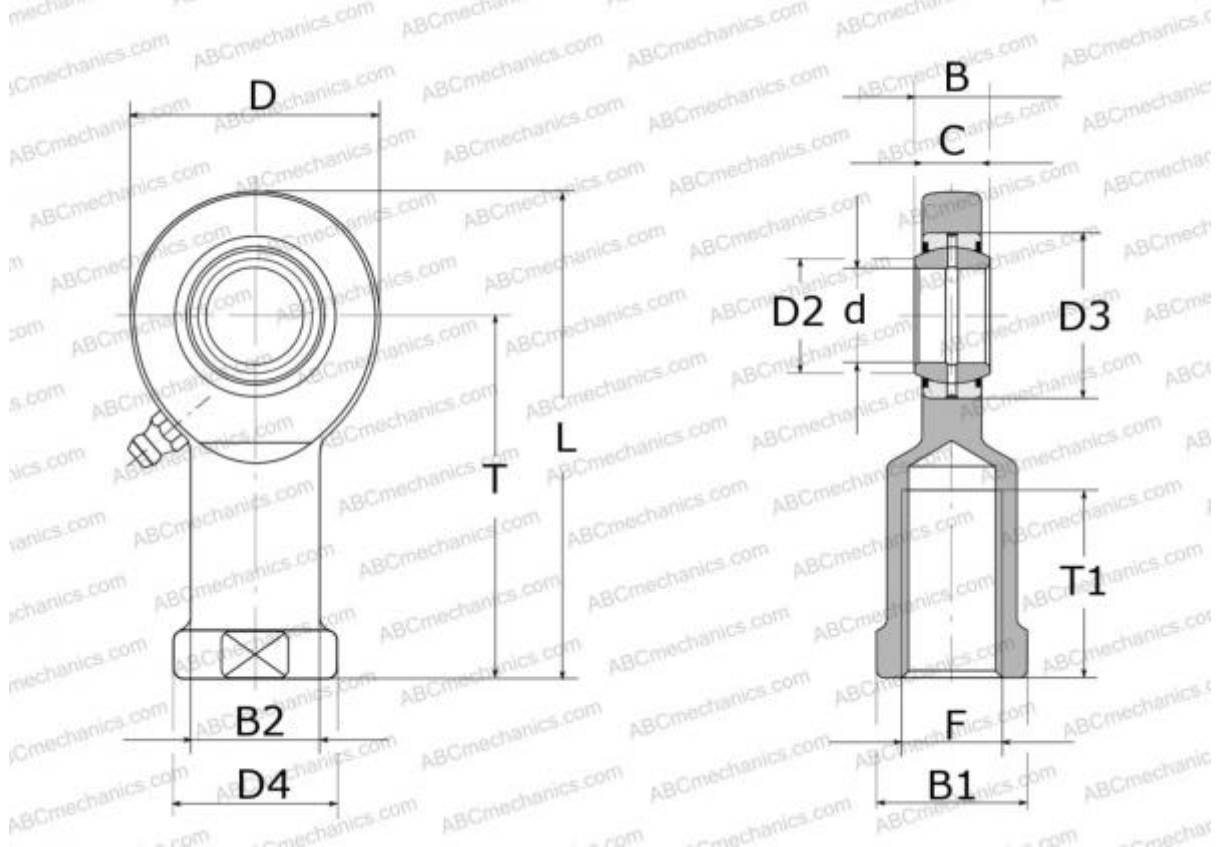

Technical specification

DIMENSIONS, MM

d	60,000
D	137,000
D4	82,000
B	44,000
B1	70,000
L	296,000
T	225,000
T1	70,000
C	39,000
F	M60x4

WEIGHT, KG 7,100

MANUFACTURER [SKF](https://www.skf.com)

CALCULATION DATA

Basic dynamic load rating, C	245,000 kN
Basic static load rating, Co	400,000 kN