

SIQG 20 ES SKF

Rod ends

TYPE: Plain bearings, Spherical plain bearings and rod ends, Rod ends, Hydraulic, Requiring maintenance, with thread clamping device, open design, right hand thread, series SIJ..ES, SIQG..ES (SKF)

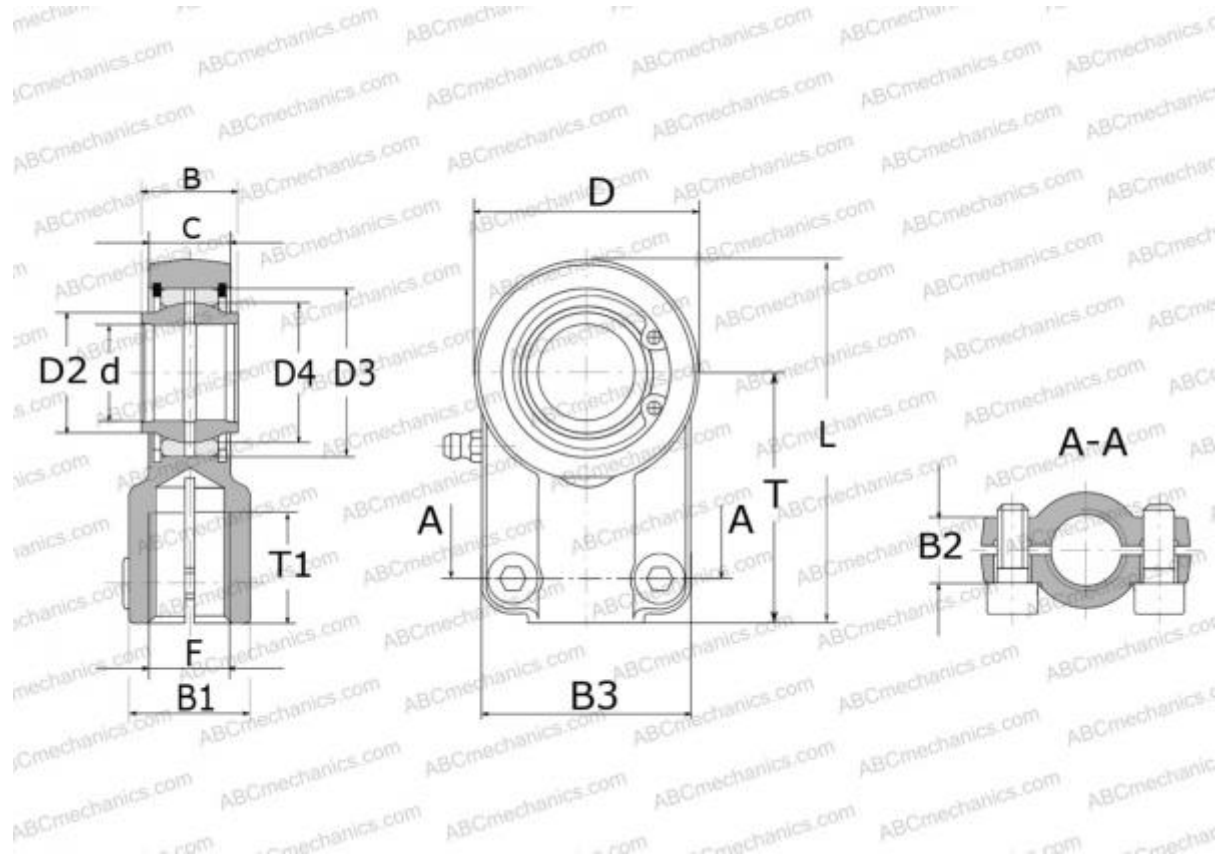

Technical specification

DIMENSIONS, MM

d	20,000
D	48,000
D4	29,000
B	20,000
B1	26,500
B2	18,000
B3	48,000
L	77,000
T	52,000
T1	23,000
C	17,500
F	M16x1.5

CALCULATION DATA

Basic dynamic load rating, C	30,000 kN
Basic static load rating, Co	43,000 kN

MANUFACTURER

[SKF](#)