

SILJ 20 ES SKF

Rod ends

TYPE: Plain bearings, Spherical plain bearings and rod ends, Rod ends, Hydraulic, Requiring maintenance, with thread clamping device, open design, left hand thread, series SILJ..ES, SILQG..ES (SKF)

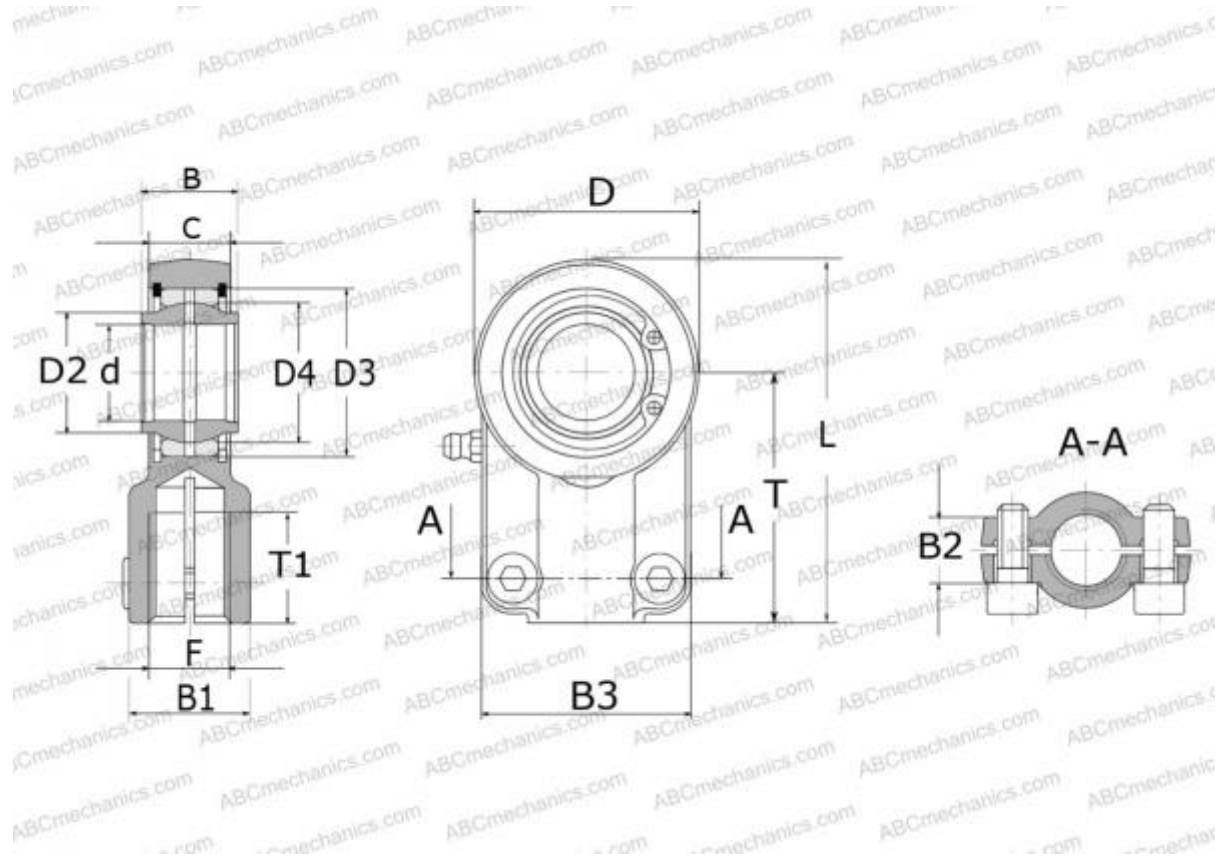

Technical specification

DIMENSIONS, MM

d	20,000
D	55,000
D4	29,000
B	16,000
B1	25,000
B2	17,000
B3	55,000
L	85,500
T	58,000
T1	19,000
C	13,000
F	M14x1.5

CALCULATION DATA

Basic dynamic load rating, C	30,000 kN
Basic static load rating, Co	51,000 kN

MANUFACTURER

[SKF](#)