

SIR 60 ES SKF

Rod ends

TYPE: Plain bearings, Spherical plain bearings and rod ends, Rod ends, Hydraulic, Requiring maintenance, with thread clamping device, open design, right hand thread, series SIR..ES (SKF)

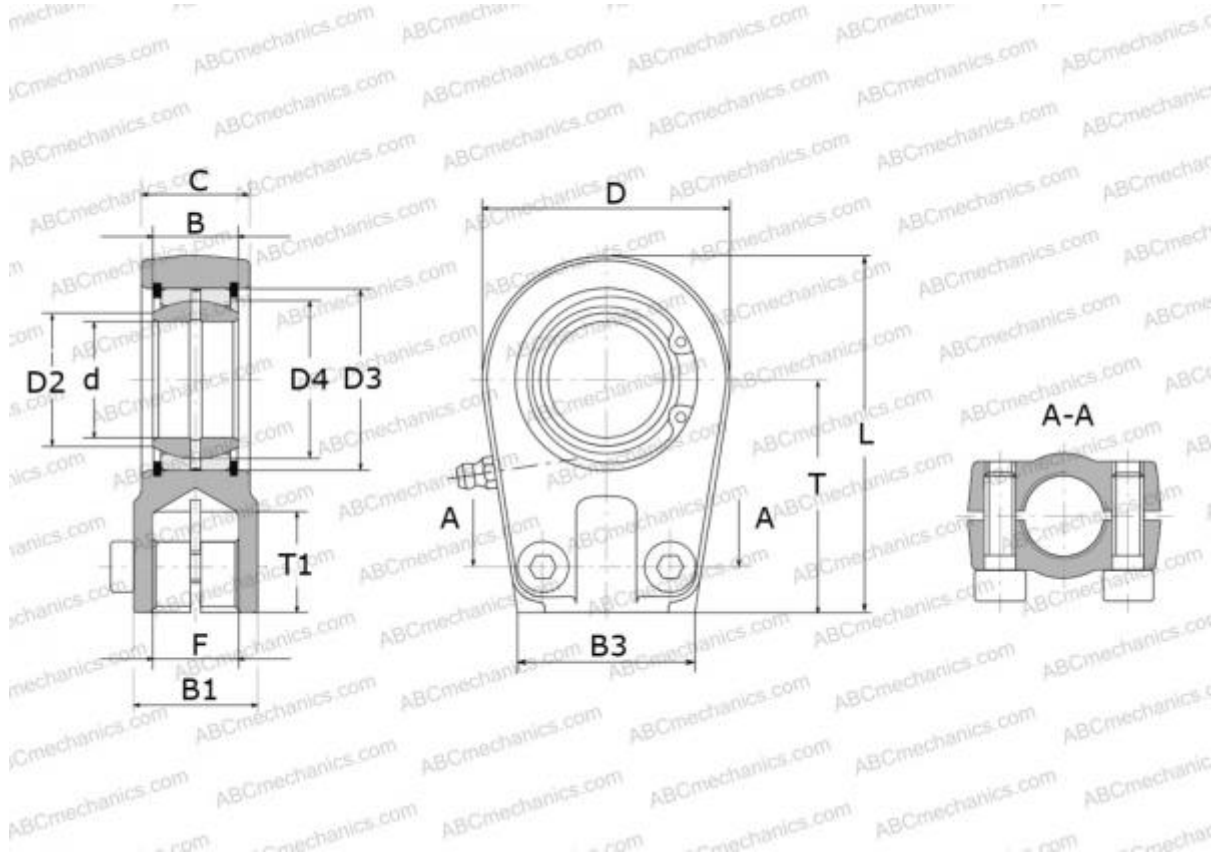

Technical specification

DIMENSIONS, MM

d	60,000
D	132,000
D4	80,000
B	44,000
B1	76,500
B2	50,500
B3	91,000
L	202,500
T	130,000
T1	59,000
C	50,500
F	M58x1.5

CALCULATION DATA

Basic dynamic load rating, C	245,000 kN
Basic static load rating, Co	325,000 kN

MANUFACTURER

[SKF](http://www.skf.com)