

SIR 100 ES SKF

Rod ends

TYPE: Plain bearings, Spherical plain bearings and rod ends, Rod ends, Hydraulic, Requiring maintenance, with thread clamping device, open design, right hand thread, series SIR..ES (SKF)

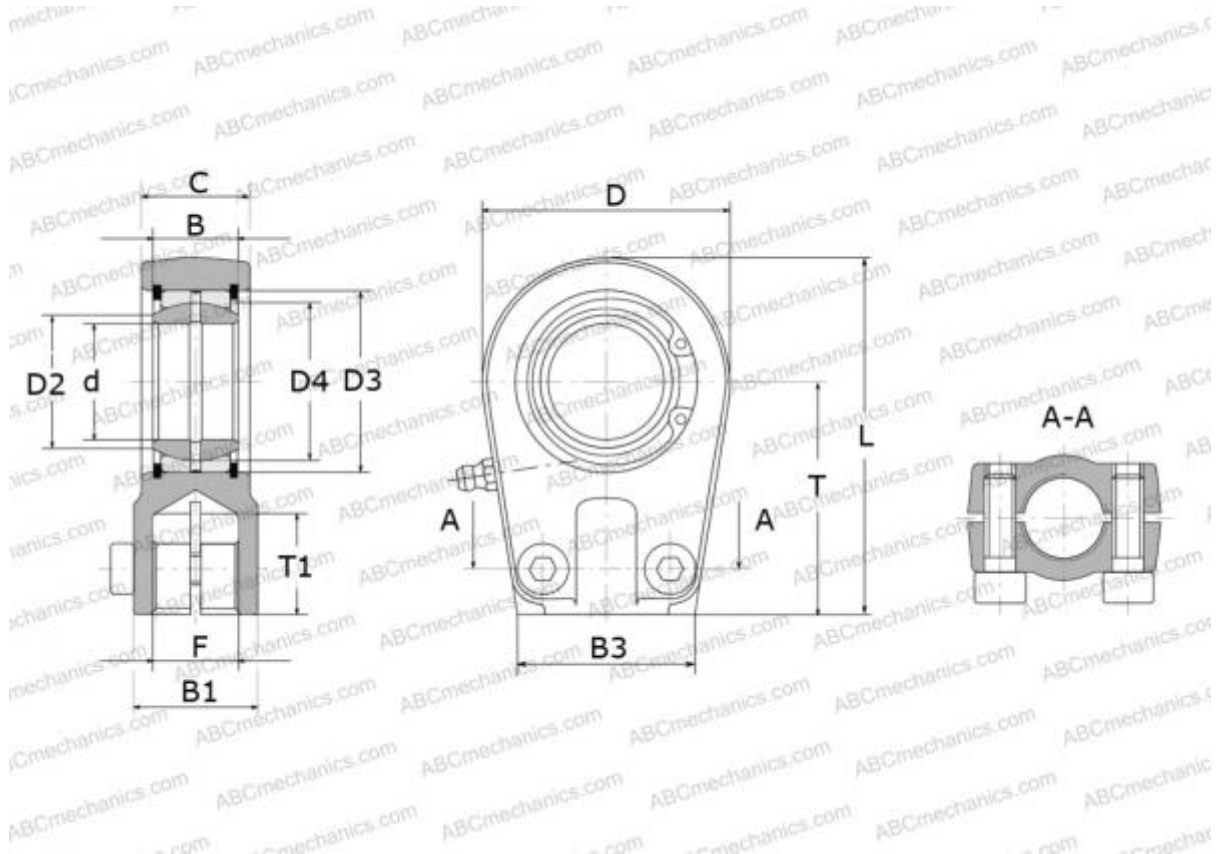

Technical specification

DIMENSIONS, MM

d	100,000
D	232,000
D4	130,000
B	70,000
B1	140,000
B2	70,500
B3	167,000
L	362,500
T	235,000
T1	111,000
C	70,500
F	M110x2

CALCULATION DATA

Basic dynamic load rating, C	610,000 kN
Basic static load rating, Co	950,000 kN

MANUFACTURER

[SKF](http://www.skf.com)