

SILR 35 ES SKF

Rod ends

TYPE: Plain bearings, Spherical plain bearings and rod ends, Rod ends, Hydraulic, Requiring maintenance, with thread clamping device, open design, left hand thread, series SILR..ES (SKF)

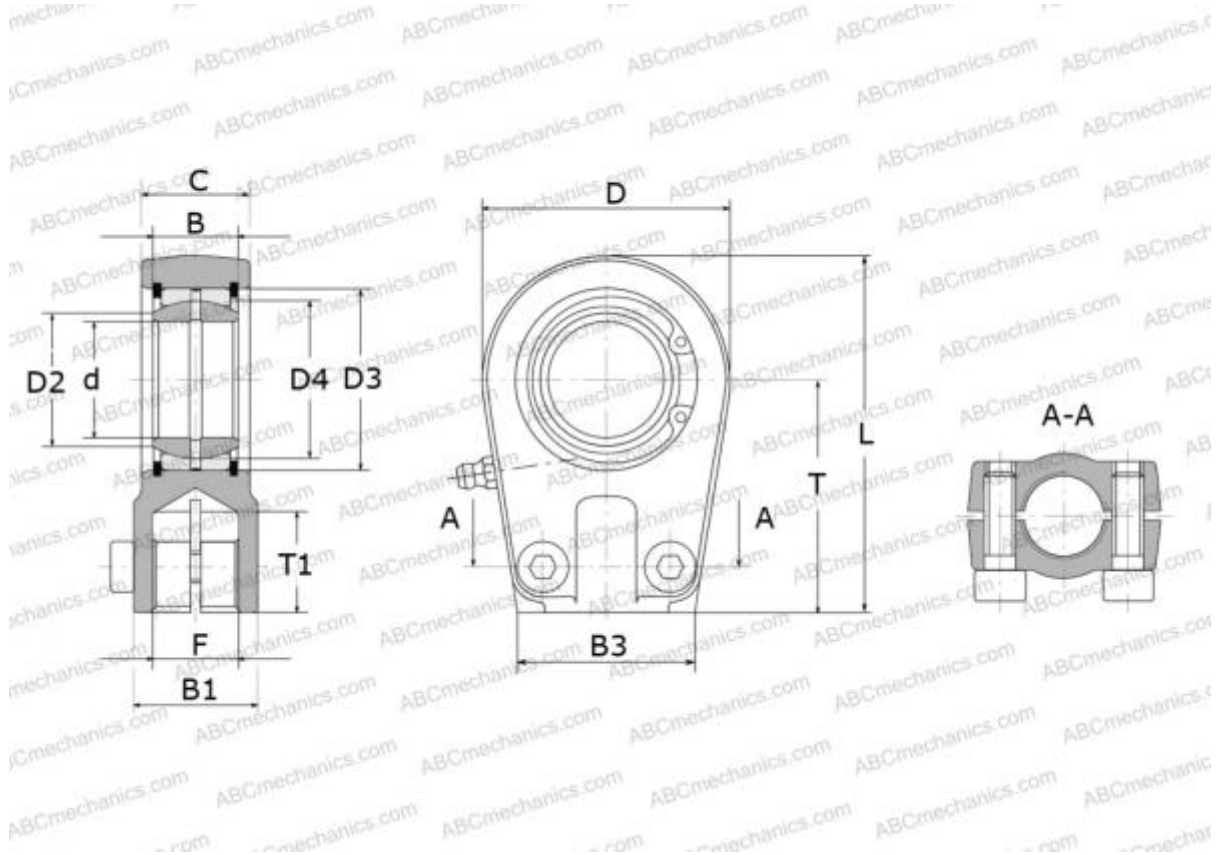

Technical specification

DIMENSIONS, MM

d	35,000
D	79,000
D4	47,000
B	25,000
B1	41,500
B2	30,500
B3	59,000
L	110,500
T	70,000
T1	29,000
C	30,500
F	M28x1.5

WEIGHT, KG 1,200

MANUFACTURER

[SKF](#)

CALCULATION DATA

Basic dynamic load rating, C	80,000 kN
Basic static load rating, Co	118,000 kN