

SILR 50 ES SKF

Rod ends

TYPE: Plain bearings, Spherical plain bearings and rod ends, Rod ends, Hydraulic, Requiring maintenance, with thread clamping device, open design, left hand thread, series SILR..ES (SKF)

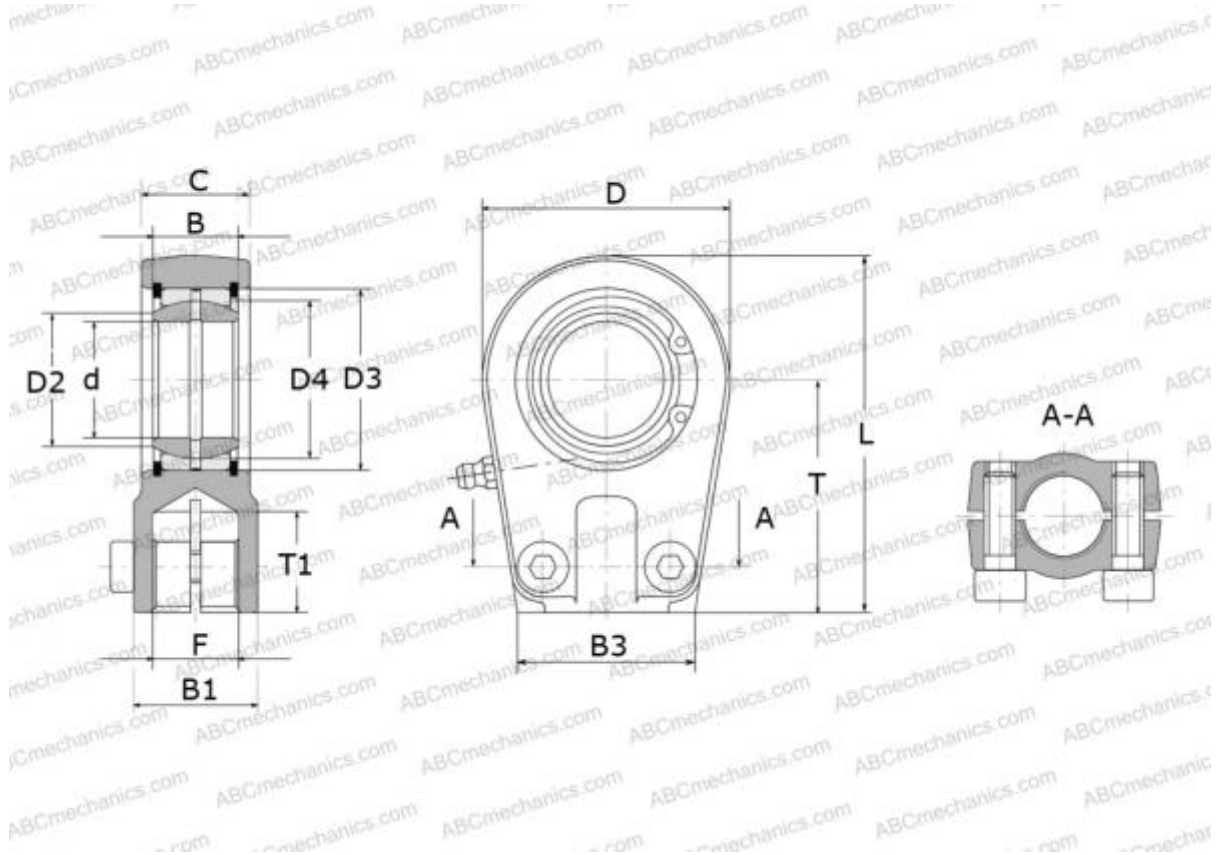

Technical specification

DIMENSIONS, MM

d	50,000
D	118,000
D4	66,000
B	35,000
B1	62,500
B2	40,500
B3	89,000
L	164,500
T	105,000
T1	46,000
C	40,500
F	M45x1.5

WEIGHT, KG 3,600

MANUFACTURER

[SKF](#)

CALCULATION DATA

Basic dynamic load rating, C	156,000 kN
Basic static load rating, Co	280,000 kN