

SILR 80 ES SKF

Rod ends

TYPE: Plain bearings, Spherical plain bearings and rod ends, Rod ends, Hydraulic, Requiring maintenance, with thread clamping device, open design, left hand thread, series SILR..ES (SKF)

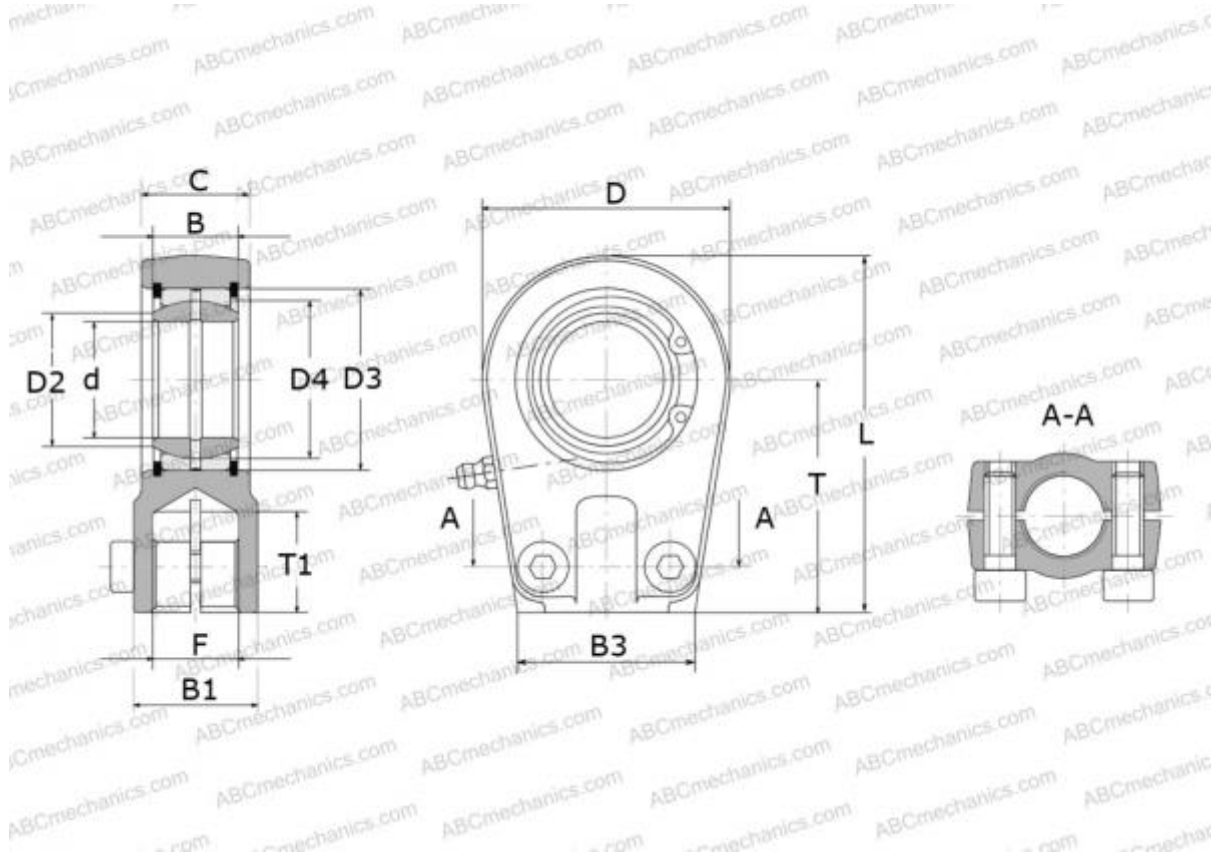

Technical specification

DIMENSIONS, MM

d	80,000
D	178,000
D4	105,000
B	55,000
B1	103,500
B2	60,500
B3	126,000
L	267,500
T	170,000
T1	81,000
C	60,500
F	M80x2

WEIGHT, KG 13,000

MANUFACTURER

[SKF](#)

CALCULATION DATA

Basic dynamic load rating, C	400,000 kN
Basic static load rating, Co	560,000 kN