

## SA 8 E SKF

Rod ends

TYPE: Plain bearings, Spherical plain bearings and rod ends, Rod ends, Requiring maintenance, With external thread, open design, right hand thread, series SA..ES (SKF)

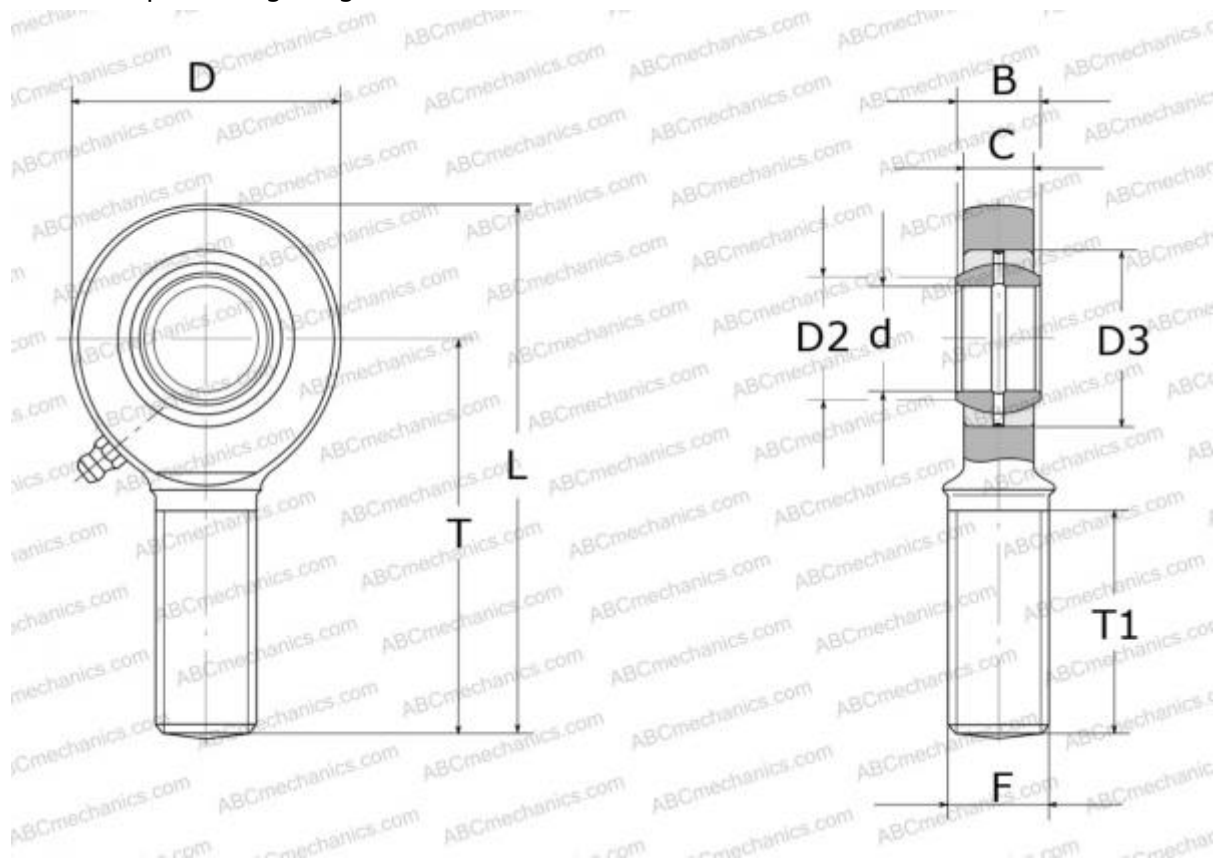

### Technical specification

#### DIMENSIONS, MM

d	8,000
D	25,000
B	8,000
L	56,000
T	42,000
T1	21,000
C	6,500
F	M8

#### MANUFACTURER

[SKF](#)

#### CALCULATION DATA

Basic dynamic load rating, C	5,500 kN
Basic static load rating, Co	12,900 kN