

SAL 17 ES SKF

Rod ends

TYPE: Plain bearings, Spherical plain bearings and rod ends, Rod ends, Requiring maintenance, With external thread, open design, left hand thread, series SAL..ES (SKF)

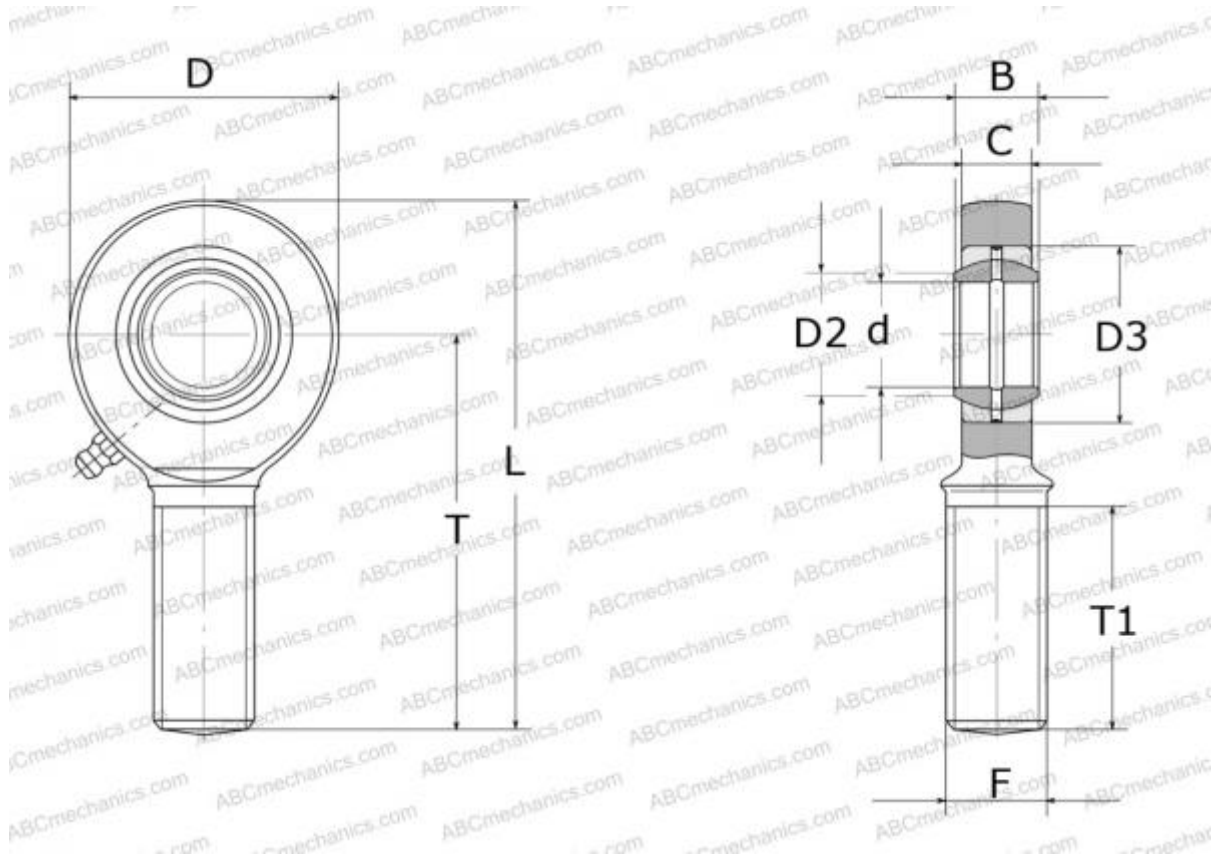

Technical specification

DIMENSIONS, MM

d	17,000
D	47,000
B	14,000
L	94,000
T	69,000
T1	36,000
C	11,500
F	M16

WEIGHT, KG 0,190

MANUFACTURER [SKF](#)

CALCULATION DATA

Basic dynamic load rating, C	21,200 kN
Basic static load rating, Co	31,000 kN