

SALA 40 ES-2RS SKF

Rod ends

TYPE: Plain bearings, Spherical plain bearings and rod ends, Rod ends, Requiring maintenance, With external thread, open design, left hand thread, series SAL(A)..ES-2RS (SKF)

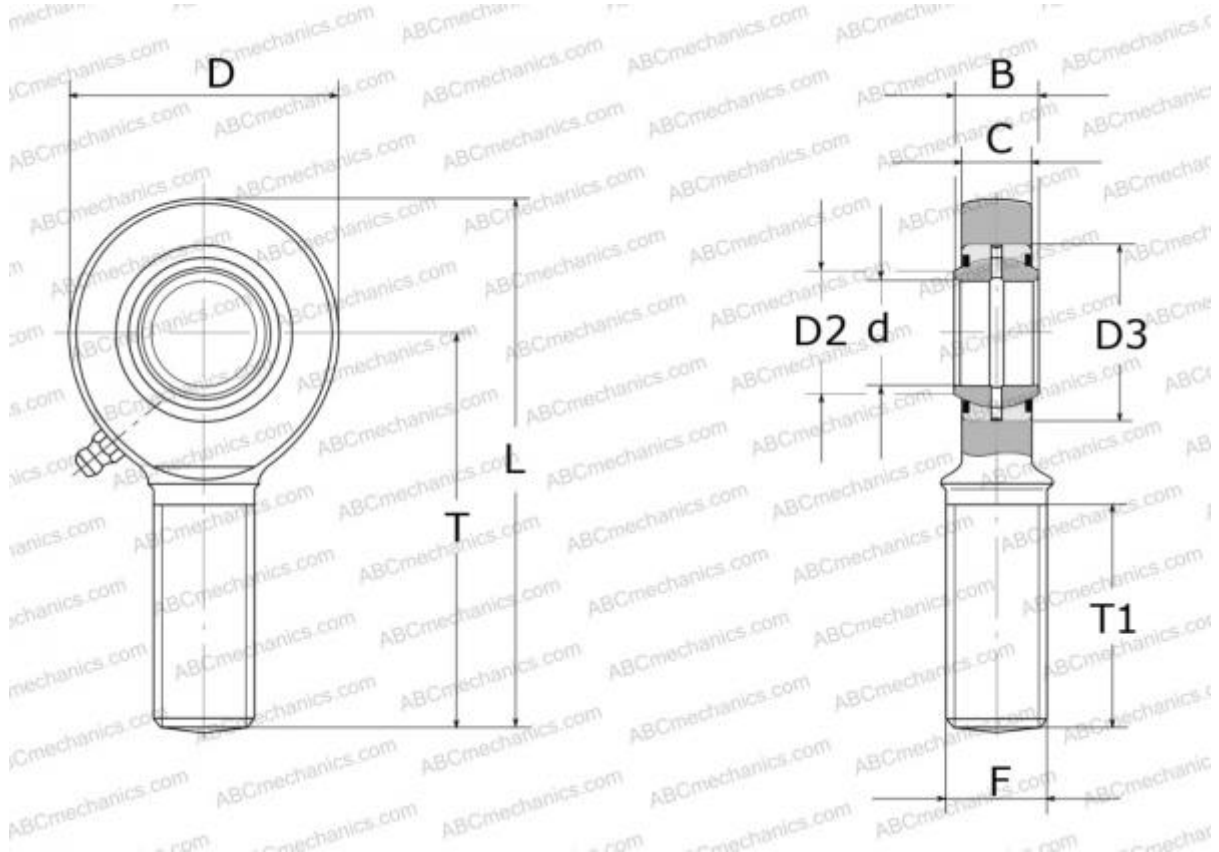

Technical specification

DIMENSIONS, MM

d	40,000
D	94,000
B	28,000
L	199,000
T	150,000
T1	86,000
C	24,000
F	M39x3

WEIGHT, KG 1,850

MANUFACTURER [SKF](#)

CALCULATION DATA

Basic dynamic load rating, C	100,000 kN
Basic static load rating, Co	140,000 kN