

SAL 50 ES-2RS SKF

Rod ends

TYPE: Plain bearings, Spherical plain bearings and rod ends, Rod ends, Requiring maintenance, With external thread, open design, left hand thread, series SAL(A)..ES-2RS (SKF)

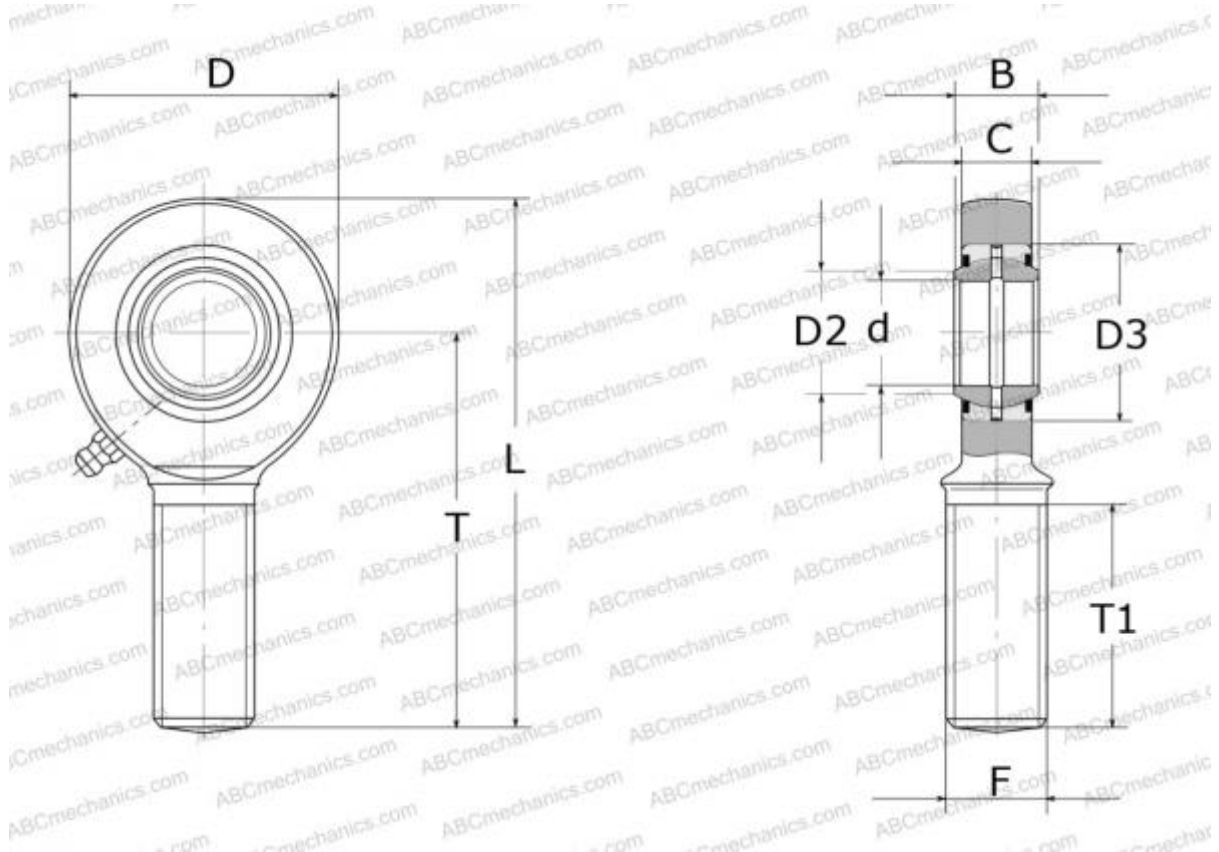

Technical specification

DIMENSIONS, MM

d	50,000
D	114,000
B	35,000
L	254,000
T	195,000
T1	110,000
C	31,000
F	M52x3

WEIGHT, KG 3,900

MANUFACTURER [SKF](#)

CALCULATION DATA

Basic dynamic load rating, C	156,000 kN
Basic static load rating, Co	245,000 kN