

GE 12 AX INA

Spherical plain bearings

TYPE: Plain bearings, Spherical plain bearings and rod ends, Thrust spherical plain bearings, Requiring maintenance, Series GE..-AX (INA)

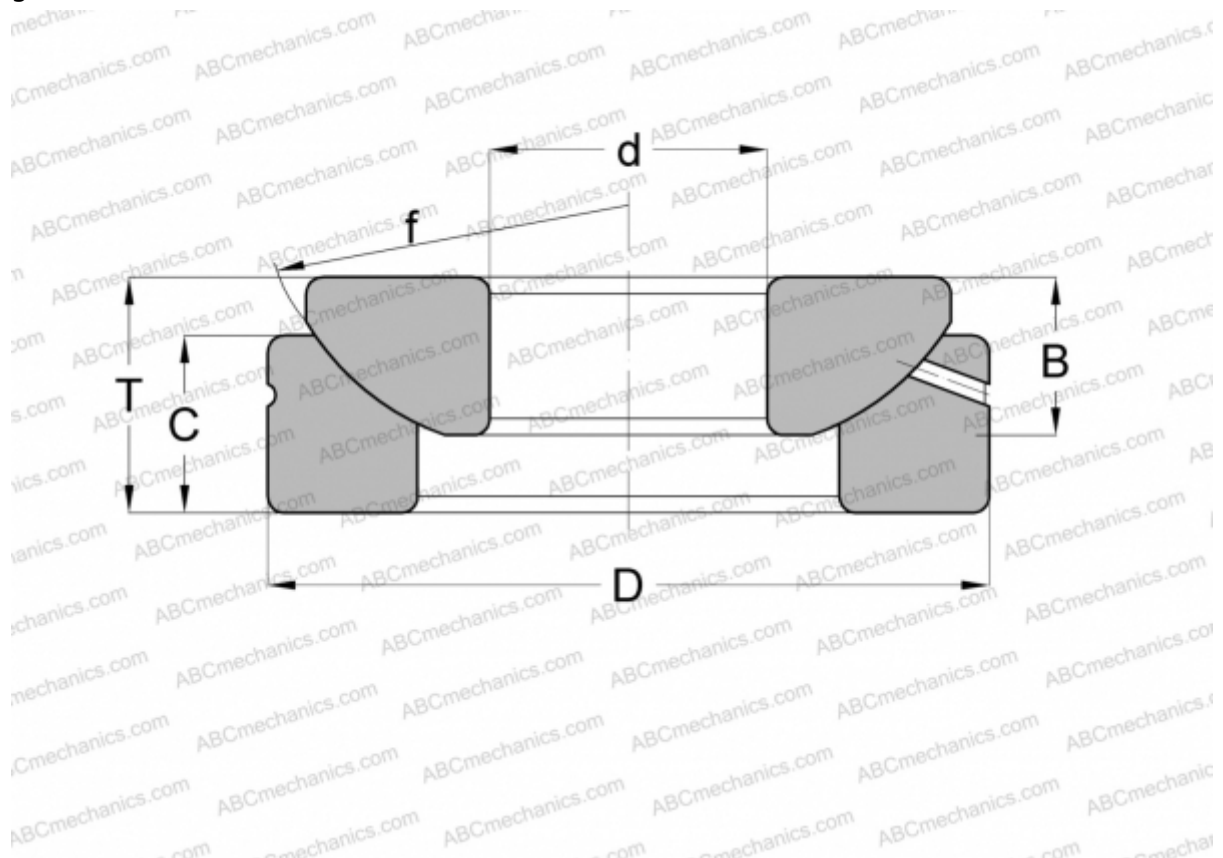

Technical specification

DIMENSIONS, MM

d	12,000
D	35,000
B	9,300
f	37,000
T	13,000

MANUFACTURER

[INA](#)