

GIR 25 UK 2RS INA

TYPE: Plain bearings, Spherical plain bearings and rod ends, Rod ends, Maintenance free, With internal thread, with lip seals or high performance seals, right hand thread, series GIR..-UK-2RS (INA)

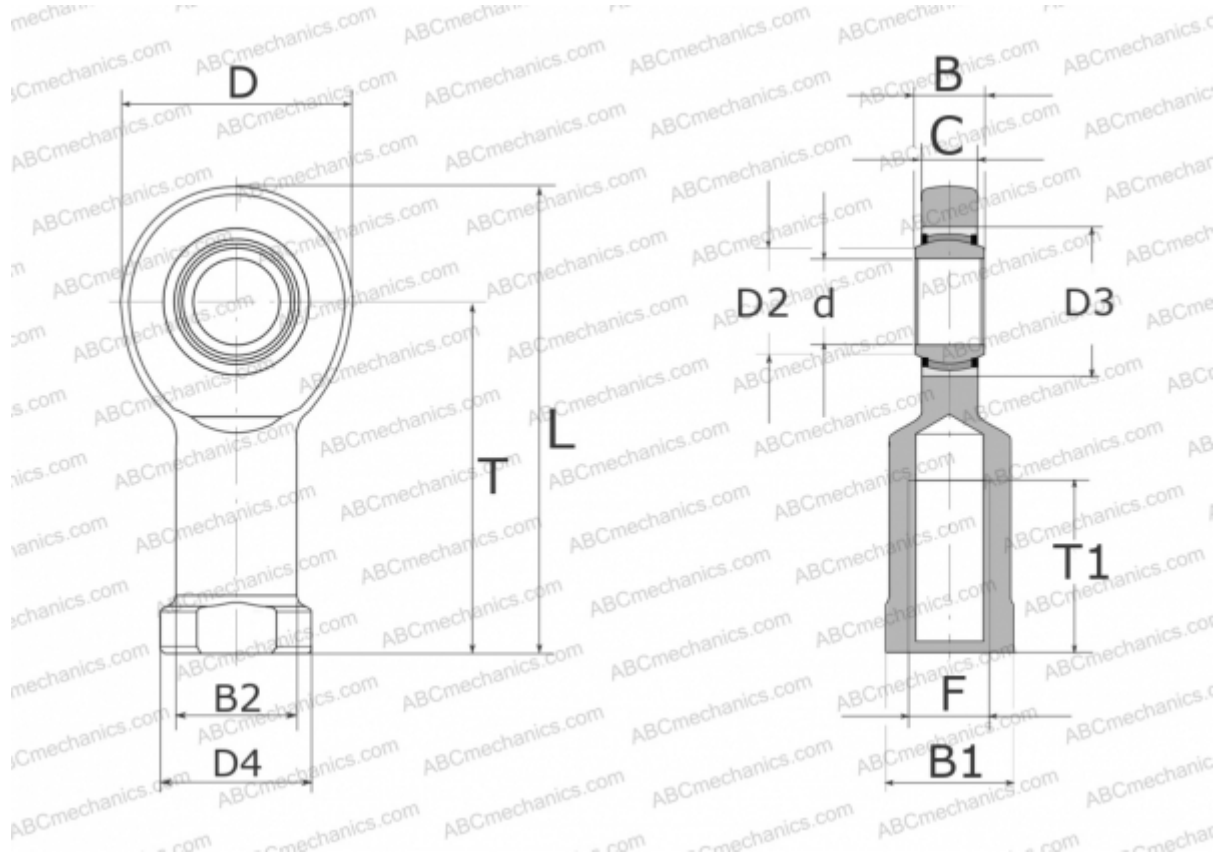

Technical specification

DIMENSIONS, MM

d	25,000
D	64,000
D2	29,300
D3	42,000
D4	42,000
B	20,000
B1	36,000
B2	33,500
L	126,000
T	94,000
T1	48,000
C	17,000
F	M24X2

MANUFACTURER

[INA](#)